

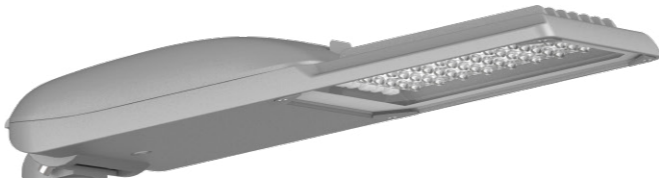

D-212 Series



D-212L
120-200W



D-212S
60-100W



D-212S1
25-60W

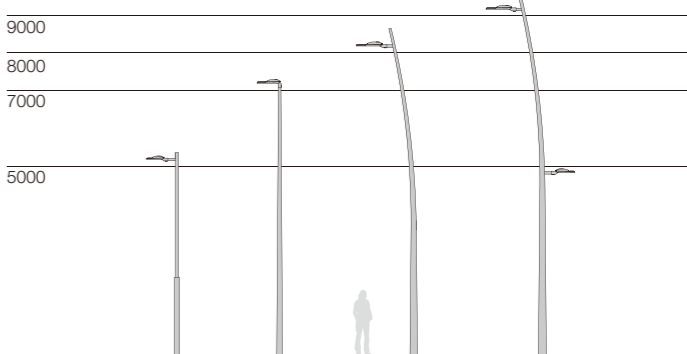



IP66电器腔室，灯具打开时有支撑杆防护和自动断电装置，有效保护灯具安全

IP66 electrical box housing, when the lighting open there is support rod protection and automatic power-off device to effectively protect the safety.



简洁的外形设计，配不锈钢扣攀设计，打开无需工具

Simple shape design, with stainless steel locker design, free tools to open.



D-212 Series

一组经济型LED路灯，功能齐全，造型简洁大方，从平凡中体现不平凡的设计理念。灯具功率范围从25W-200W。

A group of economic LED street lighting, with full complete functions and simple and generous modeling, reflects the extraordinary design concept from the ordinary. The lamp power range is from 25W to 200W.



灯具具有横装、竖装二种方式，角度可以-10~+10度调节，安装座有Ø60 / Ø48 / Ø76 mm 供选择

Top or side fitting Ø60mm, Ø48mm, Ø76 arm be option, from -10° ~ +10° angle adjustable.

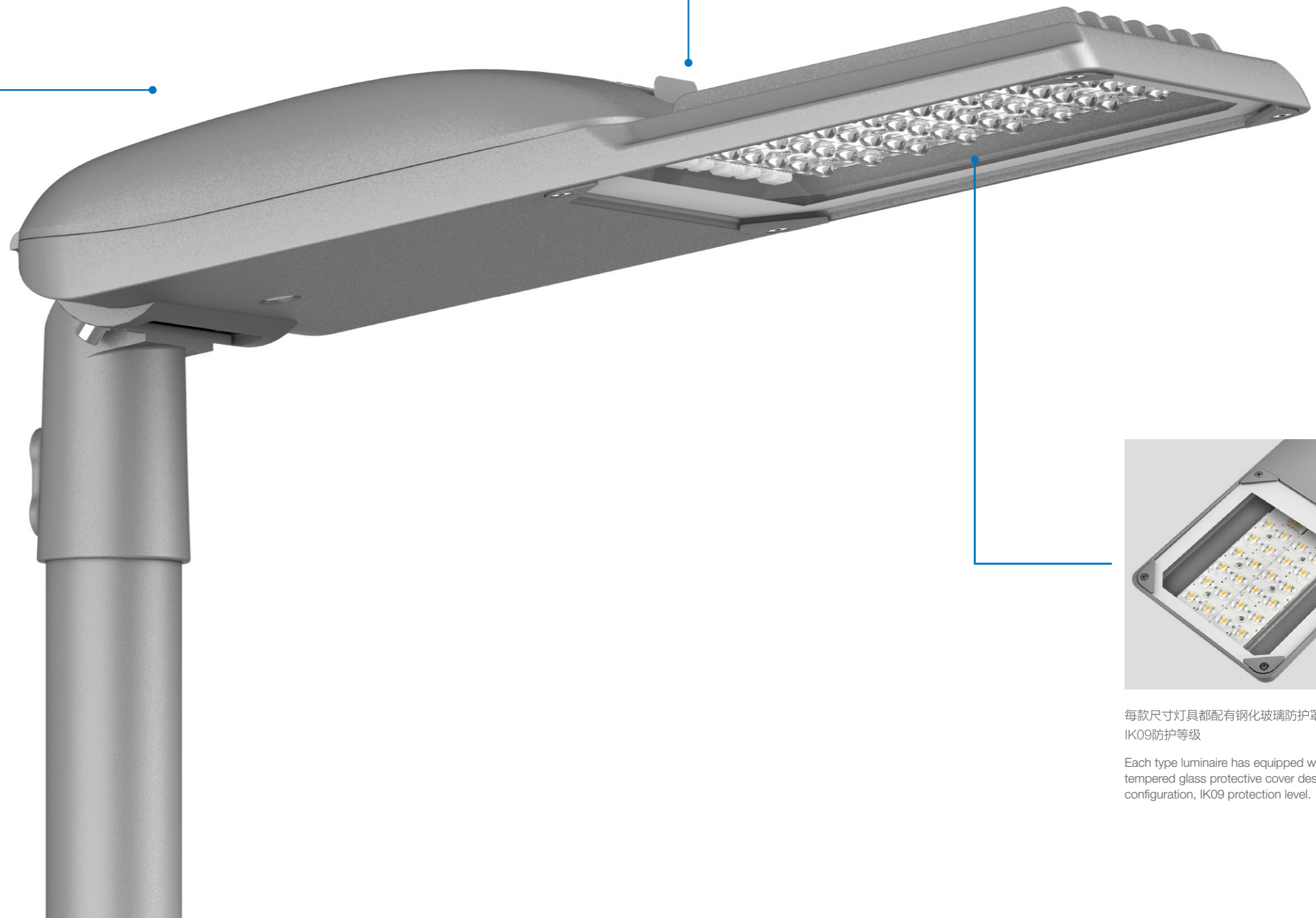

每款尺寸灯具都配有钢化玻璃防护罩设计配置，IK09防护等级

Each type luminaire has equipped with tempered glass protective cover design configuration, IK09 protection level.

简述 Description



- 铝压铸灯体外壳，超白钢化玻璃
- 高透光PC透镜，具有高视觉舒适性和均匀配光透镜，供多种不同配光选择
- 高性能LED芯片，驱动有0-10V / DALI / 编程电源选择，20KV浪涌保护器
- 弹性不锈钢扣攀开启方式，设有开启断电保护器
- 有侧装和顶装2种安装方式，角度可调，安装管径有 $\varnothing 48 / \varnothing 60 / \varnothing 76$ mm
- 防紫外线聚氨酯塑料喷涂表面，盐雾测试可达1000小时以上
- 无生物蓝光危害风险，符合EN62471: 2008标准
- 道路灯智能远程控制控制系统可选，可以与远程管理系统兼容
- 所有外部螺钉均为304不锈钢材质

- Die-casting aluminium body, super white tempered glass.
- Optics with PC lens with high visual comfortable and uniform lighting distribution, multiple light distribution options.
- High quality LED chips, Driver with 0-10V/DALI/programmed be options, and with surge protection up to 20KV.
- Tool-free replaceable, stainless steel fasten for opened device, automatic on/off connector when be open.
- Top and side fixing, angle can be adjustable, installation tube diameter $\varnothing 48/\varnothing 60/\varnothing 76$ mm.
- Surface anti-ultraviolet pure polyester powder painting, Corrosion resistance can be more than 1000 hours.
- No photo-biological risk, (no risk linked to infrared, blue light and UV radiation) in accordance with EN 62471:2008.
- Street lighting control used with smart control technology. It can be compatible with remote management system.
- All external screws are made of 304 stainless steel.

应用透镜 Optics application

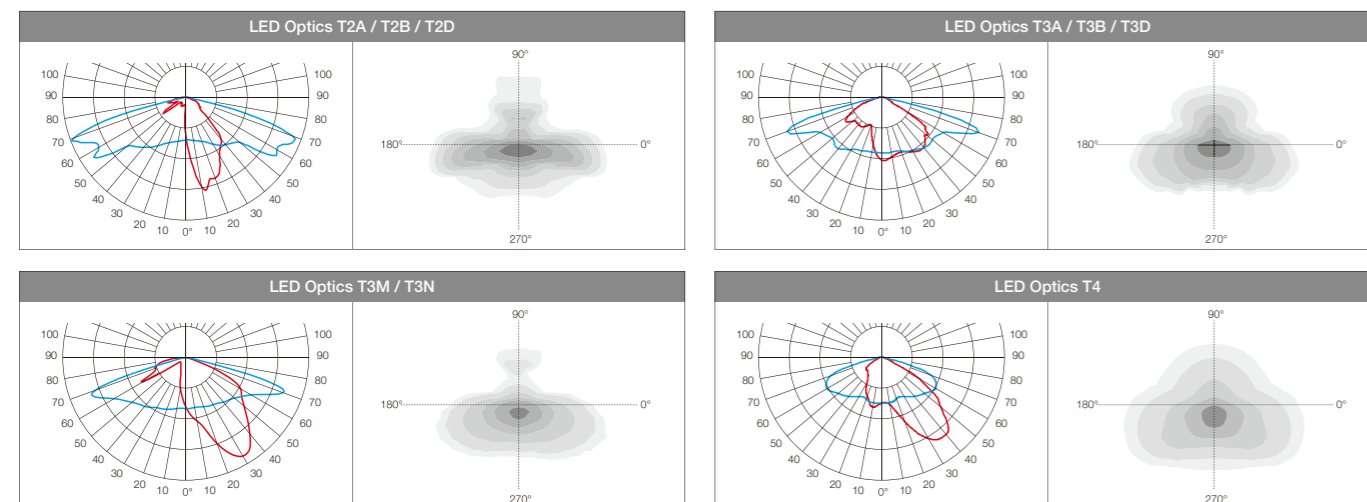

技术参数 Technology data

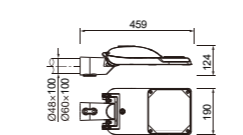
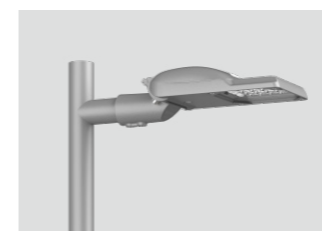
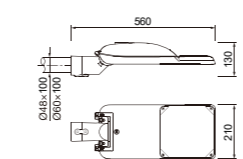
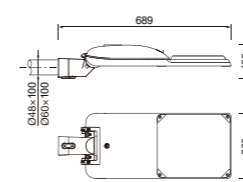

D-212L

Code	Power	LED Qty	Optics	Packing Size	Weight	Pcs/20"	Pcs/40"
LED chips - 3535/5050							
D-212LLED120-48	120W	48	T3A/T4A/T5A/T4	720*320*170	9.0	728	1495
D-212LLED150-48	150W	48	T3A/T4A/T5A/T4	720*320*170	9.0	728	1495
D-212LLED200-72	200W	72	T2D/T3D/T3N	720*320*170	9.0	728	1495

LED chips - 3030

D-212LLED150-168	150W	168	T2B/T3B/T4B	735*270*115	9.0	1170	2412
D-212LLED200-192	200W	192	T2B/T3B/T4B	735*270*115	9.0	1170	2412

D-212S

Code	Power	LED Qty	Optics	Packing Size	Weight	Pcs/20"	Pcs/40"
LED chips - 3535/5050							
D-212SLED80-24	80W	24	T3A/T4A/T3M/T4	580*220*110	5.0	1938	3933
D-212SLED100-36	100W	36	T2D/T3D/T3N	580*220*110	5.0	1938	3933

LED chips - 3030

D-212SLED60-84	60W	84	T2B/T3B/T4B	580*220*110	5.0	1938	3933
D-212SLED80-84	80W	84	T2B/T3B/T4B	580*220*110	5.0	1938	3933

D-212S1

Code	Power	LED Qty	Optics	Packing Size	Weight	Pcs/20"	Pcs/40"
LED chips - 3535/5050							
D-212S1LED25-16	25W	16	T2A/T3A/T3M/T4	480*200*110	3.8	2720	5560
D-212S1LED40-16	40W	16	T2A/T3A/T3M/T4	480*200*110	3.8	2720	5560
D-212S1LED60-24	60W	24	T2A/T3A/T3M/T4	480*200*110	3.8	2720	5560

可选配件 Accessories options

	Code
Ø76安装座 Fixing Arm	210007623
Ø60安装座 Fixing Arm	210002620
Ø48安装座 Fixing Arm	210002621

Arm / Adapter required for install on the pole.