

宁波金羽桥照明科技有限公司

NINGBO KING-BRIDGE LIGHTING  
TECHNOLOGY CO.,LTD.

地址：浙江省余姚市阳明街道新桥工业区

Add: Xinqiao Industry Zone, Yangming Street, Yuyao City,  
Zhejiang Province, China

Tel: +86-574-6256 6890

Fax: +86-574-6256 6827

info@kled.com

国内营销中心:

金羽桥照明科技（上海）有限公司

地址：上海市长宁区中山西路179号4K室

电话：189 1897 7928

**KLED**

— King-Bridge Lighting —

## Solar Street Lighting



# 太阳能路灯系列 Solar Street Lighting

EFFICIENT + ENERGY SAVING



## 太阳能灯具优势 Solar Lighting Advantages

- 绿色能源，灯具运行无成本  
Green energy, no running cost.
- 智能控制，云平台操作  
Smart intelligent control, cloud platform operation.
- 保护环境，致力于碳中和  
Protect the environment, and commit to carbon neutrality.

## 智能控制系统 Intelligent Solar Lighting System

- 定时调光输出，实现节能模式  
Timing dimming output, achieving energy-saving control.
- 红外感应模式，感应人在灯亮，人走灯暗  
PIR sensor control, the light is on when a person inducted and the light is dim when the person left.
- 根据行人流量监控，分时段调光控制  
According to pedestrian flow monitoring, dimming control in different time periods.
- 智能充放电控制，根据残余电量，自动分配光输出  
Intelligent charging control, automatically distributing light output based on residual electricity.

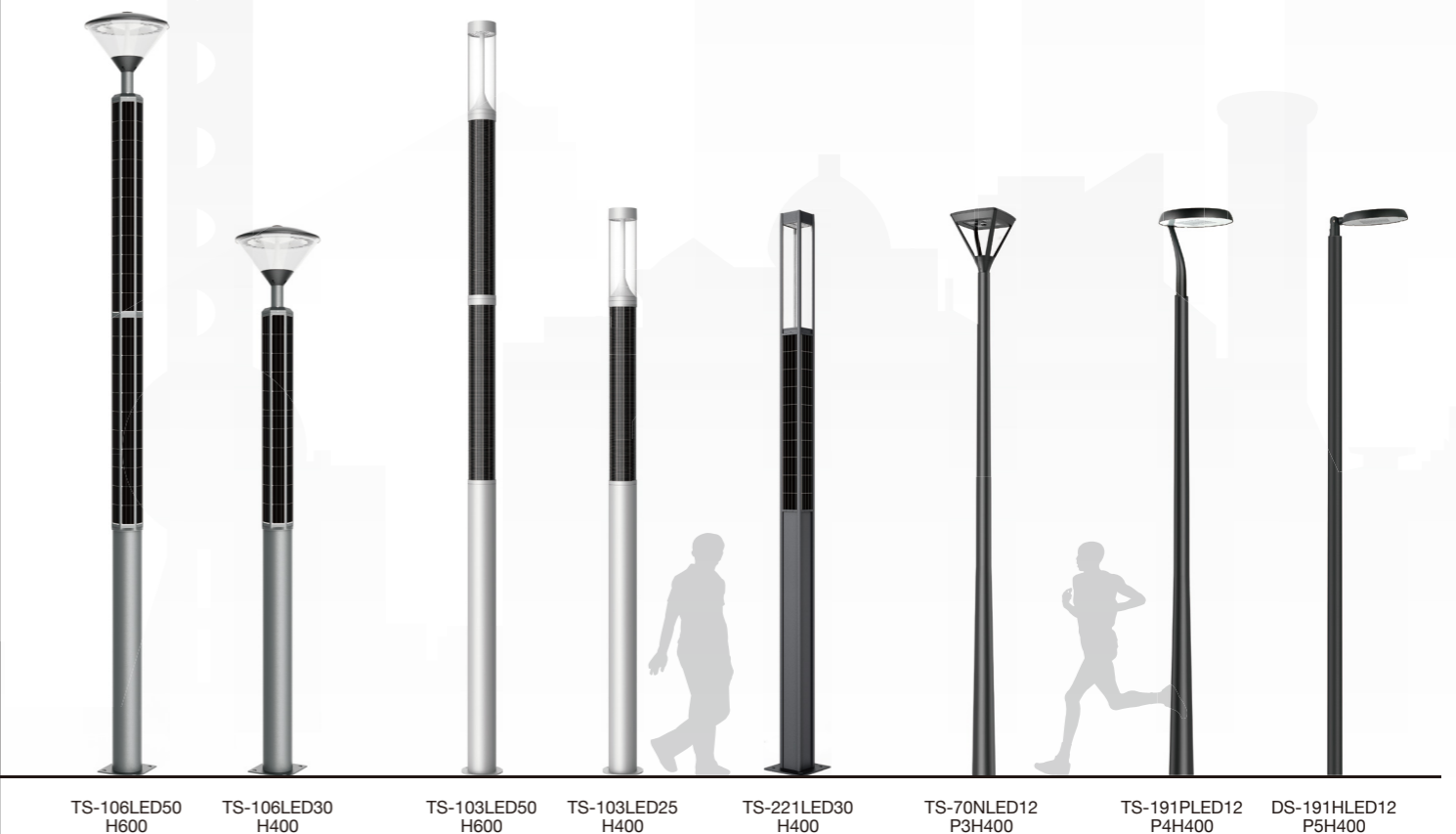





### 一体式智慧太阳能路灯 All-in-One Integrated Smart Solar Street Lighting



DS-231L

DS-231M

材料: 铝压铸灯体, 高透明钢化玻璃  
光学组件: 多种光学套件可选  
PV组件: 高效单晶硅太阳能板  
电池: 磷酸铁锂电池  
安装选项: Ø76 / Ø60mm, 侧装、竖装可选, 角度可调  
色温选项: 3000K / 4000K

Material: Die-casting aluminium body, super white tempered glass.  
Optical: Multiple optical distribution options.  
Solar Panels: Efficient monocrystalline silicon solar panels.  
Battery: Lithium iron phosphate battery.  
Fixing: Ø76 / Ø60mm, side and vertical installation options, angle adjustable.  
Colour Temperature: 3000K / 4000K.

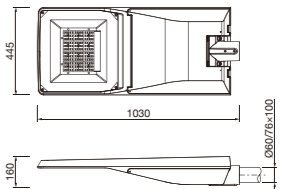

DS-231L

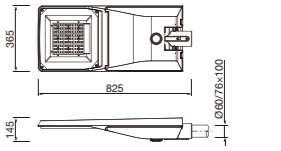

DS-231M

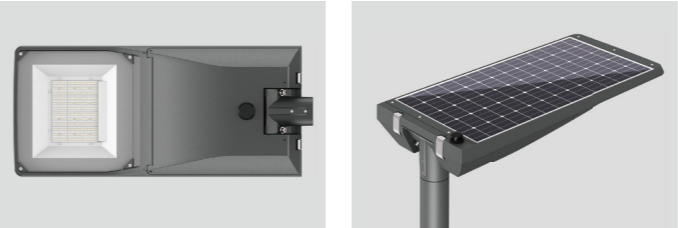

灯具型号 Model	LED灯珠 LED CHIPS	太阳能板 Solar Panel	电池 Lithium Battery	光通量 Luminous	控制方式 Control Mode	工作时间 Discharging Time	安装高度 Mounting Height	感应距离 Induction Distance
DS-231MLED40	3030*126pcs	45W	12.8V/30AH	5100 lm	PIR sensor / Timing control	>3 days	4-7M	12-15M
DS-231LLED70	3030*168pcs	75W	12.8V/60AH	8600 lm	PIR sensor / Timing control	>3 days	7-10M	12-15M





### 一体式智慧太阳能路灯 All-in-One Integrated Smart Solar Street Lighting



DS-221L

DS-221M

材料: 铝压铸灯体, 铝挤压型材边框  
 光学组件: 模组式光学透镜, 多种光学可选  
 PV组件: 高效单晶硅太阳能板  
 电池: 磷酸铁锂电池  
 安装选项: Ø76竖装, 角度可调  
 色温选项: 3000K / 4000K

Material: Die-casting aluminium body, extruded aluminium side.  
 Optical: Multiple optical distribution options.  
 Solar Panels: Efficient monocrystalline silicon solar panels.  
 Battery: Lithium iron phosphate battery.  
 Fixing: Ø76 vertical installation bracket, angle adjustable.  
 Colour Temperature: 3000K / 4000K.

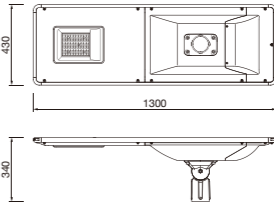

DS-221L

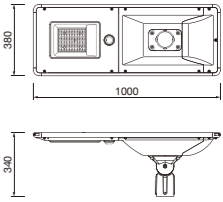

DS-221M

灯具型号 Model	LED灯珠 LED CHIPS	太阳能板 Solar Panel	电池 Lithium Battery	光通量 Luminous	控制方式 Control Mode	工作时间 Discharging Time	安装高度 Mounting Height	感应距离 Induction Distance
DS-221MLED60	3030*60pcs	60W	12.8V/45AH	7500 lm	PIR sensor / Timing control	>3 days	5-7M	12-15M
DS-221LLED100	5050*60pcs	100W	12.8V/75AH	12500 lm	PIR sensor / Timing control	>3 days	7-10M	12-15M





分体式智慧太阳能路灯  
Split Integrated  
Smart Solar Street Lighting



灯杆: 根据客户需要定制不同式样灯杆  
灯具: 多种灯具外形可选  
PV组件: 高效单晶硅太阳能板  
电池: 磷酸铁锂电池

Pole: Customize different styles of light poles according to customer needs.  
Luminaire: Many fixtures are available.  
Solar Panels: Efficient monocrystalline silicon solar panels.  
Battery: Lithium iron phosphate battery.



DS-170S1  
50-80W

DS-170S  
100W



DS-170S2  
30-40W



灯具型号 Model	LED灯珠 LED CHIPS	太阳能板 Solar Panel	电池 Lithium Battery	光通量 Luminous	控制方式 Control Mode	工作时间 Discharging Time	安装高度 Mounting Height	感应距离 Induction Distance
DS-170S2LED30	3030*56pcs	65W	12.8V/30AH	5100 lm	PIR sensor / Timing control	>3 days	4-6M	12-15M
DS-170S1LED60	3030*84pcs	120W	12.8V/60AH	10200 lm	PIR sensor / Timing control	>3 days	7-9M	12-15M
DS-170S1LED80	3030*112pcs	150W	12.8V/75AH	13600 lm	PIR sensor / Timing control	>3 days	7-9M	12-15M
DS-170SLED100	3030*168pcs	180W	25.6V/45AH	17000 lm	PIR sensor / Timing control	>3 days	8-10M	12-15M

其他可选配灯型 Others luminaire option

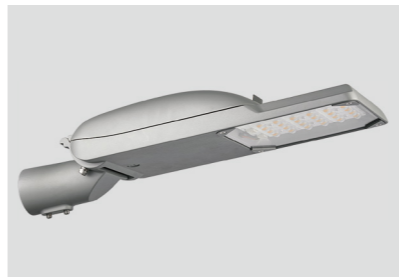

D-212 Series



D-180 Series

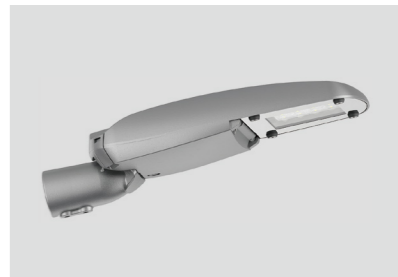

D-200 Series





TS-70N

KLED

**一体式太阳能庭院灯**  
**All-in-One Integrated Smart Solar Street Lighting**



材料: 铝压铸灯体, 高透明钢化玻璃  
 光学组件: 多种光学套件可选  
 PV组件: 高效单晶硅太阳能板  
 电池: 磷酸铁锂电池  
 安装选项: Ø76 / Ø60mm 安装支架管径  
 色温选项: 3000K / 4000K

**Material:** Die-casting aluminium body, super white tempered glass.  
**Optical:** Multiple optical distribution options.  
**Solar Panels:** Efficient monocrystalline silicon solar panels.  
**Battery:** Lithium iron phosphate battery.  
**Fixing:** Ø76 / Ø60mm vertical installation bracket.  
**Colour Temperature:** 3000K / 4000K.

TS-70N  
12W

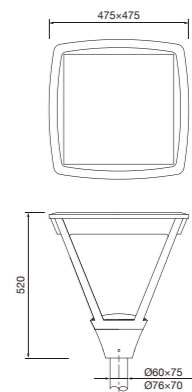

灯具型号 Model	LED灯珠 LED CHIPS	太阳能板 Solar Panel	电池 Lithium Battery	光通量 Luminous	控制方式 Control Mode	工作时间 Discharging Time	安装高度 Mounting Height	感应距离 Induction Distance
TS-70NLED12	3030*56pcs	18W	12.8V/8AH	1800 lm	PIR sensor / Timing control	>2 days	3-5M	8-10M





TS-191P

DS-191H

**一体式太阳能庭院灯**  
**All-in-One Integrated Smart Solar Street Lighting**



材料: 铝压铸灯体, 高透明钢化玻璃  
 光学组件: 多种光学套件可选  
 PV组件: 高效单晶硅太阳能板  
 电池: 磷酸铁锂电池  
 安装选项: Ø76 / Ø60mm 安装支架管径  
 色温选项: 3000K / 4000K

**Material:** Die-casting aluminium body, super white tempered glass.  
**Optical:** Multiple optical distribution options.  
**Solar Panels:** Efficient monocrystalline silicon solar panels.  
**Battery:** Lithium iron phosphate battery.  
**Fixing:** Ø76 / Ø60mm vertical installation bracket.  
**Colour Temperature:** 3000K / 4000K.

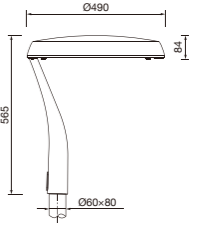

TS-191P

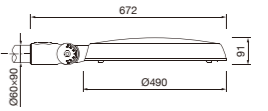
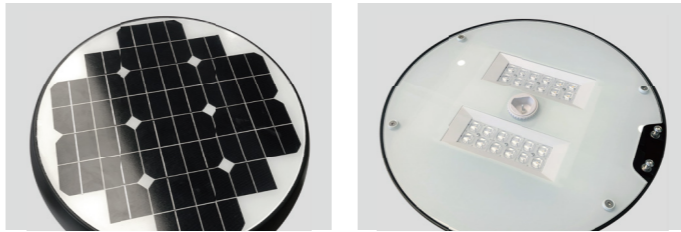

DS-191H

灯具型号 Model	LED灯珠 LED CHIPS	太阳能板 Solar Panel	电池 Lithium Battery	光通量 Luminous	控制方式 Control Mode	工作时间 Discharging Time	安装高度 Mounting Height	感应距离 Induction Distance
TS-191PLED12	3030*84pcs	25W	12.8V/8AH	1800 lm	PIR sensor / Timing control	>2 days	3-4M	8-10M
DS-191HLED12	3030*84pcs	25W	12.8V/8AH	1800 lm	PIR sensor / Timing control	>2 days	3-4M	8-10M





模组式六边太阳能柱灯  
Modular 6-Sided  
Solar Column Lighting



灯具材料: 铝压铸灯体, 高透明PC透明罩  
光学组件: 多种光学套件可选  
PV组件: 模组式高效单晶硅太阳能组件, 可以套接组装  
电池: 磷酸铁锂电池  
灯杆: Q355材质钢管, 热镀锌后喷涂处理  
色温选项: 3000K / 4000K

**Material:** Die-casting aluminium body, PC transparent diffuser.  
**Optical:** Multiple optical distribution options.  
**Solar Panels:** Efficient monocrystalline silicon solar panels.  
**Battery:** Lithium iron phosphate battery.  
**Pole:** Q355 steel pole, after galvanized process, then by anti-ultraviolet pure polyester powder painting.  
**Colour Temperature:** 3000K / 4000K.

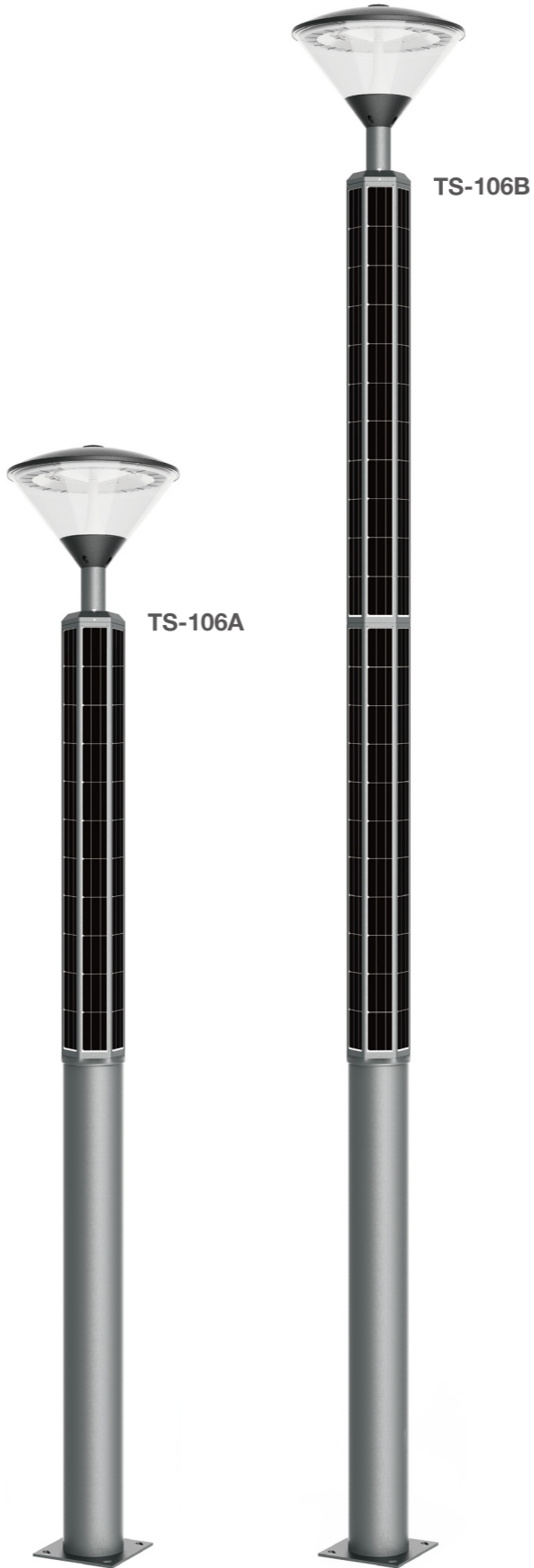

PV Module  
160W

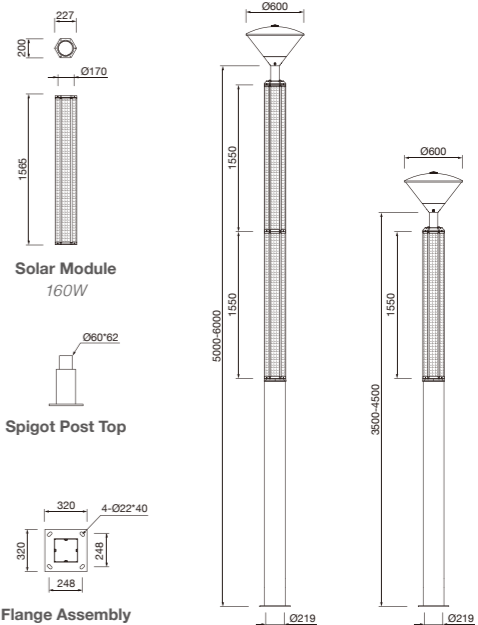

灯具型号 Model	LED灯珠 LED CHIPS	太阳能板 Solar Panel	电池 Lithium Battery	光通量 Luminous	控制方式 Control Mode	工作时间 Discharging Time	安装高度 Mounting Height
TS-106ALED30	2835*128pcs	160W	12.8V/30AH	4500 lm	Timing control	>3 days	3.5-4.5M
TS-106BLED50	2835*128pcs	320W	12.8V/45AH	7500 lm	Timing control	>3 days	5-6M





模组式圆形太阳能柱灯  
Modular  
Solar Column Lighting



灯具材料: 铝压铸灯体, 高透明PC透明管  
光学组件: 多种光学套件可选  
PV组件: 模组式高效单晶硅太阳能组件, 可以套接组装  
电池: 磷酸铁锂电池  
灯杆: Q355材质钢管, 热镀锌后喷涂处理  
色温选项: 3000K / 4000K

**Material:** Die-casting aluminium body, PC transparent diffuser tube.  
**Optical:** Multiple optical distribution options.  
**Solar Panels:** Efficient monocrystalline silicon solar panels.  
**Battery:** Lithium iron phosphate battery.  
**Pole:** Q355 steel pole, after galvanized process, then by anti-ultraviolet pure polyester powder painting.  
**Colour Temperature:** 3000K / 4000K.



PV Module  
95W



Solar Module  
95W

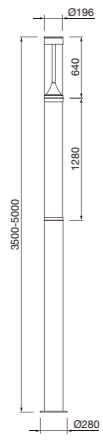

TS-103A

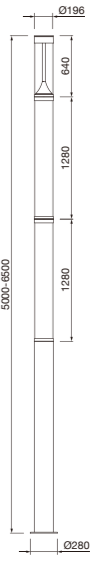

TS-103B

灯具型号 Model	LED灯珠 LED CHIPS	太阳能板 Solar Panel	电池 Lithium Battery	光通量 Luminous	控制方式 Control Mode	工作时间 Discharging Time	安装高度 Mounting Height
TS-103ALED25	3030*56pcs	95W	12.8V/30AH	4000 lm	Timing control	>2 days	3.5-5M
TS-103BLEDD50	3030*96pcs	190W	12.8V/45AH	6500 lm	Timing control	>2 days	5-6.5M



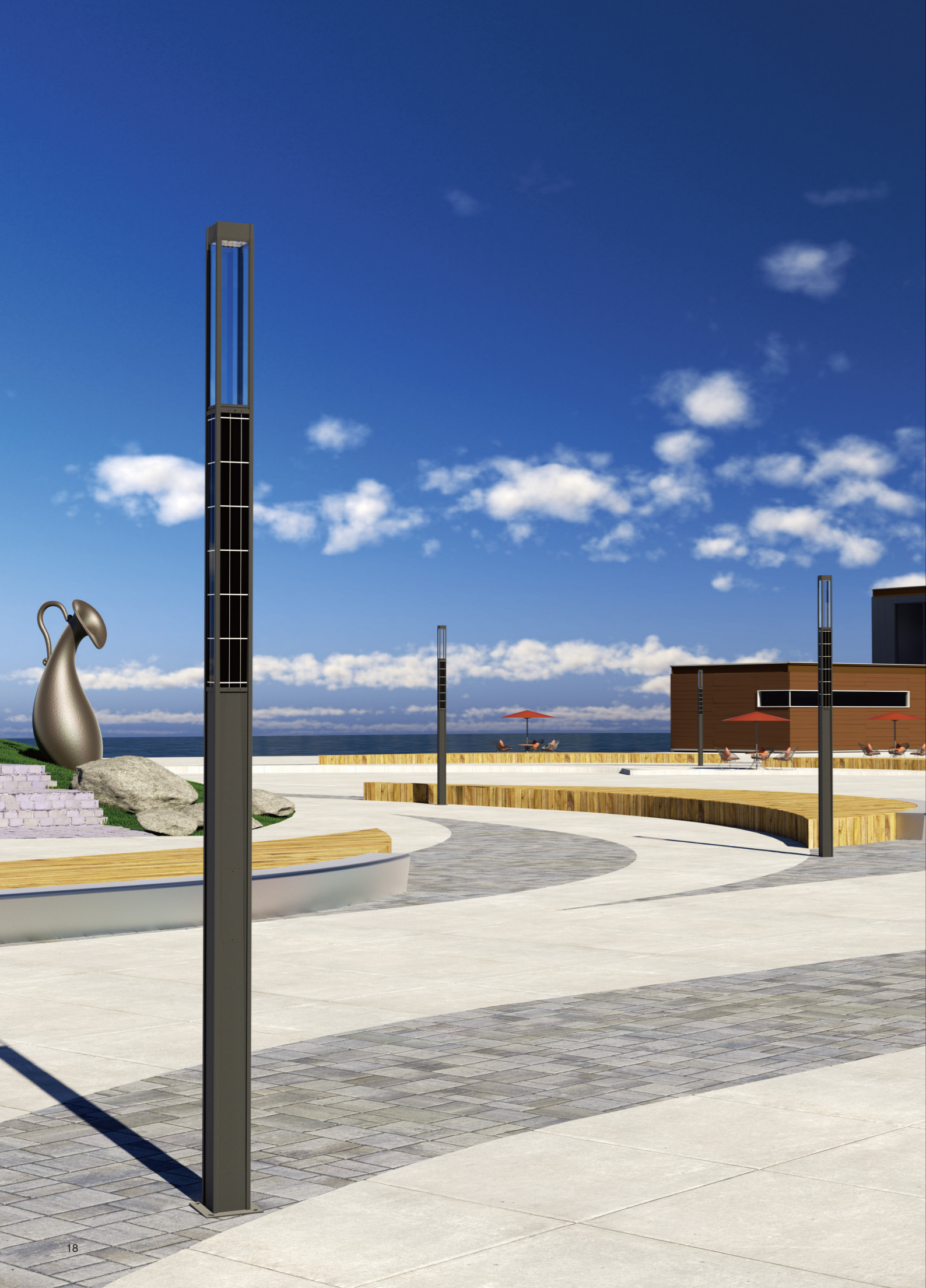

TS-221

KLED

一体式四方太阳能柱灯  
Integrated Solar Square  
Column Lighting

TS-221



材料: 铝压铸灯体, 铝挤压型材立柱, 透明PC板  
光学组件: 模组式光学透镜, 多种光学可选  
PV组件: 高效单晶硅太阳能板  
电池: 磷酸铁锂电池  
灯杆: 铝型材喷涂处理  
色温选项: 3000K / 4000K

**Material:** Die-casting aluminium body, extruded aluminium pole, PC transparent diffuser.  
**Optical:** Multiple optical distribution options.  
**Solar Panels:** Efficient monocrystalline silicon solar panels.  
**Battery:** Lithium iron phosphate battery.  
**Pole:** Extruded aluminium pole after painting process.  
**Colour Temperature:** 3000K / 4000K.

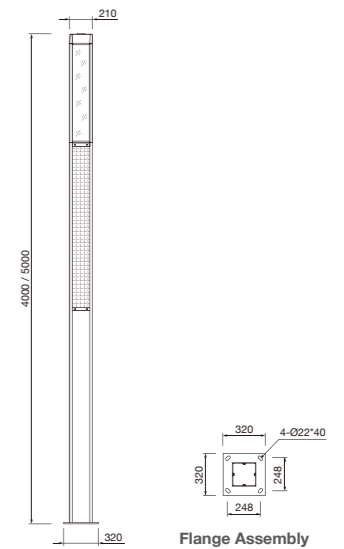

灯具型号 Model	LED灯珠 LED CHIPS	太阳能板 Solar Panel	电池 Lithium Battery	光通量 Luminous	控制方式 Control Mode	工作时间 Discharging Time	安装高度 Mounting Height
TS-221LED30-H400	5050*24pcs	160W	12.8V/30AH	4000 lm	Timing control	>3 days	4M
TS-221LED40-H500	5050*24pcs	160W	12.8V/45AH	5500 lm	Timing control	>3 days	5M



## 太阳能圆形草坪灯 Solar Circular Bollard Lighting



- 具有180° 和360° 两种配光
- 铝压铸盖帽，铝合金拉伸灯体，可根据需要截取不同高度
- 高透明PC扩散罩，能有效防止发黄老化
- 灯具采用间接投射发光模式，具有很好的视觉舒适性
- 采用高效磷酸铁锂电池
- 防紫外线聚氨酯粉喷涂表面，耐腐蚀可以达1000小时以上
- 低电压设计，安全可靠
- 一体化包装，运输方便

- With 180° or 360° light distribution.
- Aluminum die casting cover, extruded aluminum body, it can be cut different height.
- High transparent PC diffuser, it can effectively prevent yellowing and aging.
- Indirect light luminaire for use with led, which has high visual comfortable.
- With LiFePO<sub>4</sub> battery which usually apply for electric bus.
- Surface anti-ultraviolet pure polyester powder painting.
- Low voltage design, safe and Reliable.
- Integrated package, convenient transportation.



CS-233A

CS-233B

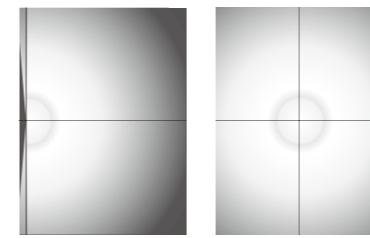

Light emission 180°

Light emission 360°

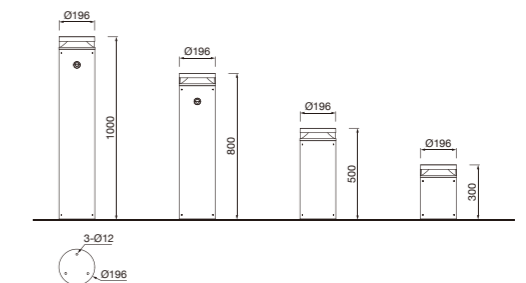

灯具型号 Model	额定功率 Rated Power	LED灯珠 LED CHIPS	太阳能板 Solar Panel	电池 Lithium Battery	光通量 Luminous	控制方式 Control Mode	工作时间 Discharging Time	安装高度 Mounting Height
CS-233A-H30	3W	2835*80pcs	4W	3.2V/6AH	270 lm	PIR sensor	>3 days	0.3M
CS-233B-H30	3W	2835*40pcs	4W	3.2V/6AH	270 lm	PIR sensor	>3 days	0.3M
CS-233A-H50	3W	2835*80pcs	4W	3.2V/6AH	270 lm	PIR sensor	>3 days	0.5M
CS-233B-H50	3W	2835*40pcs	4W	3.2V/6AH	270 lm	PIR sensor	>3 days	0.5M
CS-233A-H80	3W	2835*80pcs	4W	3.2V/6AH	270 lm	PIR sensor	>3 days	0.8M
CS-233B-H80	3W	2835*40pcs	4W	3.2V/6AH	270 lm	PIR sensor	>3 days	0.8M
CS-233A-H100	3W	2835*80pcs	4W	3.2V/6AH	270 lm	PIR sensor	>3 days	1M
CS-233B-H100	3W	2835*40pcs	4W	3.2V/6AH	270 lm	PIR sensor	>3 days	1M





太阳能方形草坪灯  
Solar Square  
Bollard Lighting



- 具有360° 的配光
- 铝压铸盖帽，铝合金拉伸灯体，可根据需要截取不同高度
- 高透明PC扩散罩，能有效防止发黄老化
- 灯具采用间接投射发光模式，具有很好的视觉舒适性
- 采用高效磷酸铁锂电池
- 防紫外线聚氨酯塑粉喷涂表面，耐腐蚀可以达1000小时以上
- 低电压设计，安全可靠
- 一体化包装，运输方便

- With 360° light distribution.
- Aluminum die casting cover, extruded aluminum body, it can be cut different height.
- High transparent PC diffuser, it can effectively prevent yellowing and aging.
- Indirect light luminaire for use with led, which has high visual comfortable.
- With LiFePO<sub>4</sub> battery which usually apply for electric bus.
- Surface anti-ultraviolet pure polyester powder painting.
- Low voltage design, safe and Reliable.
- Integrated package, convenient transportation.



CS-234A  
4W

CS-234B  
4W

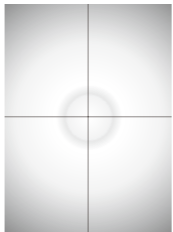

Light emission 360°

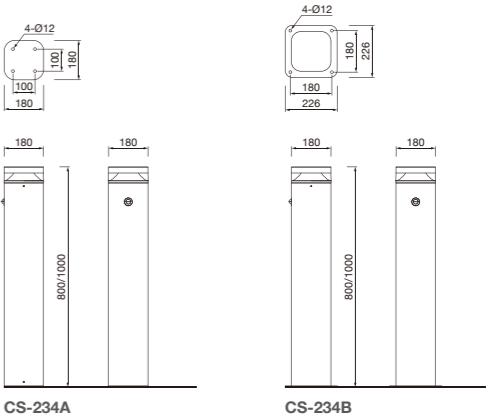

灯具型号 Model	额定功率 Rated Power	LED灯珠 LED CHIPS	太阳能板 Solar Panel	电池 Lithium Battery	光通量 Luminous	控制方式 Control Mode	工作时间 Discharging Time	安装高度 Mounting Height
CS-234A-H80	4W	2835*80pcs	5W	3.2V/6AH	350 lm	PIR sensor	>3 days	0.8M
CS-234B-H80	4W	2835*80pcs	5W	3.2V/6AH	350 lm	PIR sensor	>3 days	0.8M
CS-234A-H100	4W	2835*80pcs	5W	3.2V/6AH	350 lm	PIR sensor	>3 days	1M
CS-234B-H100	4W	2835*80pcs	5W	3.2V/6AH	350 lm	PIR sensor	>3 days	1M