

宁波金羽桥照明科技有限公司

NINGBO KING-BRIDGE LIGHTING
TECHNOLOGY CO.,LTD.

地址：浙江省余姚市阳明街道新桥工业区

Add: Xinqiao Industry Zone, Yangming Street, Yuyao City,
Zhejiang Province, China

Tel: +86-574-6256 6890

Fax: +86-574-6256 6827

info@kled.com

国内营销中心:

金羽桥照明科技（上海）有限公司

地址：上海市长宁区中山西路179号4K室
电话：189 1897 7928

KLED

— King-Bridge Lighting —

Street Lighting



KLED.com



Street Lighting

It suitable for installation in urban road, country Road, Residential area and square light field.

P6	D-221S	P112	T-151
P14	D-200	P118	T-92
P20	D-212	P126	T-91
P26	D-211	P130	T-85M
P36	D-210	P134	T-75M
P40	D-202 / T-202	P142	T-02
P48	T-191 / D-191	P146	T-01
P56	T-190	P150	T-70
P66	D-180	P156	T-10
P70	D-170	P160	T-05
P80	T-160L / D-160H	P164	T-101
P84	D-150	P170	T-102
P90	D-120	P178	T-231
P94	D-34 / T-32L	P184	T-221
P94	D-32	P192	T-219
P102	D-21H / T-21L	P198	T-232
P108	D-20H / T-20L	P202	LED Module



D-221S P6 NEW
 D-200 P14 NEW
 D-212 P20 NEW
 D-211 P26 NEW
 D-210 P36 NEW
 D-202 / T-202 P40 NEW

Power	40-75W	25-240W	40-180W	40-240W	75-180W	30-150W
Light flux LM	6000→11250	3750→36000	6000→26000	6200→37000	11000→26000	4350→21800
Colour temperature K	3000 / 4000	3000 / 4000	3000 / 4000	3000 / 4000	3000 / 4000	3000 / 4000
Dark sky application (IDA)	●	●	●	-	●	-
Wireless controls	●	●	●	●	●	-
Number of size	1	3	2	4	1	6
Wall-mounted	●	●	●	-	-	●
Fixing tube diameter	Ø60 / Ø48	Ø76 / Ø60 / Ø48	Ø60 / Ø48	Ø60 / Ø48	Ø60 / Ø48	Ø60 / Ø48



T-191L / T-191P P48 NEW
 D-191H / D-191S P48 NEW
 T-190A / T-190N P56 NEW
 T-190V P56 NEW
 T-190B / T-190C P56 NEW
 D-180 P66 NEW
 D-170 P70 NEW

Power	40-75W	40-75W	30-60W	40-75W	40-60W	25-150W	25-350W
Light flux LM	6000→11250	6000→11250	3750→6800	4600→10000	5600→8400	3750→22500	3500→49000
Colour temperature K	3000 / 4000	3000 / 4000	3000 / 4000	3000 / 4000	3000 / 4000	3000 / 4000	3000 / 4000
Dark sky application (IDA)	●	●	●	-	-	●	●
Wireless controls	●	●	-	-	-	●	●
Number of size	2	2	1	1	2	2	5
Wall-mounted	●	●	●	●	●	●	●
Fixing tube diameter	Ø76 / Ø60	Ø60 / Ø38	Ø60	Ø60	Ø60	Ø76 / Ø60 / Ø48	Ø76 / Ø60 / Ø48



T-160L / D-160H P80
 D-150 P84
 D-120 P90
 D-34 / T-32L P94
 D-32 / D-32S P94
 D-21H / T-21L P102

Power	40-100W	25-200W	25-180W	40-100W	40-100W	40-100W
Light flux LM	5800→15000	3650→29000	3650→25000	5800→14500	5800→14500	5800→14500
Colour temperature K	3000 / 4000	3000 / 4000	3000 / 4000	3000 / 4000	3000 / 4000	3000 / 4000
Dark sky application (IDA)	●	●	-	-	-	-
Wireless controls	●	●	-	-	-	-
Number of size	2	3	3	2	2	2
Wall-mounted	●	●	●	●	-	-
Fixing tube diameter	Ø76 / Ø60 / Ø48	Ø76 / Ø60 / Ø48	Ø76 / Ø60 / Ø48	Ø76 / Ø60 / Ø48	Ø60 / Ø38	Ø76 / Ø60 / Ø48



D-20H / T-20L P108
 T-151 P112
 T-92 P118 NEW
 T-91 P126
 T-85M P130
 T-75MN / T-75MI P134
 T-75MS / T-75MW P134

Power	40-100W	30-60W	60-180W	30-75W	30-75W	30-75W	30-75W
Light flux LM	5800→14500	4000→8400	8400→25000	4000→10000	3750→9300	3750→9300	3750→9300
Colour temperature K	3000 / 4000	3000 / 4000	3000 / 4000	3000 / 4000	3000 / 4000	3000 / 4000	3000 / 4000
Dark sky application (IDA)	-	-	-	-	-	-	-
Wireless controls	-	-	-	-	-	-	-
Number of size	2	1	4	1	3	2	2
Wall-mounted	-	-	●	●	●	●	●
Fixing tube diameter	Ø76 / Ø60 / Ø48	Ø76 / Ø60	Ø48 / Ø38	Ø48 / Ø38	Ø60	Ø60	3/4" / Ø38



T-02 / T-02B P142 NEW
 T-01 P146
 T-70 P150 NEW
 T-10 P156 NEW
 T-05 P160
 T-101 P164 NEW

Power	30-75W	30-75W	30-100W	25-75W	40-75W	50W
Light flux LM	3750→9300	3750→9300	4350→11000	3000→9000	4800→9000	5800
Colour temperature K	3000 / 4000	3000 / 4000	3000 / 4000	3000 / 4000	3000 / 4000	3000 / 4000
Dark sky application (IDA)	-	-	●	-	-	-
Wireless controls	-	-	-	-	-	-
Number of size	2	1	2	2	1	2
Wall-mounted	-	-	●	-	-	-
Fixing tube diameter	Ø76 / Ø60	Ø76 / Ø60	Ø76 / Ø60	Ø60	Ø76 / Ø60	-



T-102 / T-102SM P170 NEW
 T-231 P178 NEW
 T-221 / T-221SM P184 NEW
 T-219 P192 NEW
 T-232 P198 NEW
 LED Module P202

Power	60W	40-120W	60W	150-360W	40-120W	10-120W
Light flux LM	5000	4000→12000	6000	22000→52000	6000→18000	1500→18000
Colour temperature K	3000 / 4000	3000 / 4000	3000 / 4000	3000 / 4000	3000 / 4000	3000 / 4000
Dark sky application (IDA)	-	-	-	●	●	-
Wireless controls	●	-	●	●	●	-
Number of size	2	3	2	3	2	7
Wall-mounted	-	-	-	-	●	-
Fixing tube diameter	-	-	-	Ø76	-	-





D-221S

KLED



D-221S
40-75W

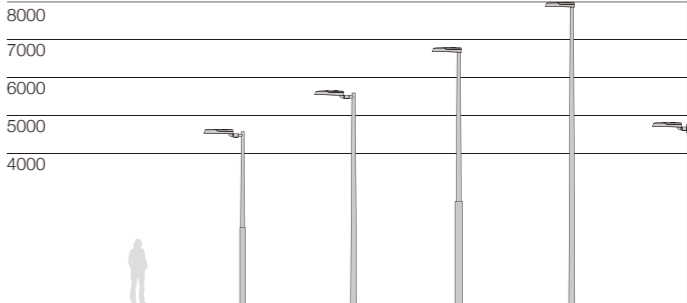



D-221S

一款实用型高端LED路灯，有三种安装方式，功率从40W-75W，可适用于不同道路功能照明需求，多种光学系统可选配。

A practical high-end LED street lighting, there are three installation methods, with power from 40W to 75W. It can be used for lighting requirements of different road functions. A variety of optical systems can be options.



IP66电器腔室，灯具打开时有支撑杆防护，有效保护灯具安全

IP66 electrical box housing, when the lighting open there is support rod protection to effectively protect the safety.



简洁的外形设计，配按钮式开启装置，打开无需工具

Simple shape design, Tool-free replaceable with push-button for opened device.



灯具有横装、竖装二种方式

Top or side fitting Ø60mm.



KLED智能感应设备，通过监控行人及车流量识别，自动调节灯具光通量输出

Kled intelligent sensing equipment can automatically adjust the luminous flux output by monitoring pedestrian and traffic flow identification.



IK08钢化玻璃罩，可适配Zhaga标准PCB板，模组透镜供多种不同光型可选

IK08 tempered glass, it is suitable for zhaga standard PCB board. Modular lens is available for various light types.

简述 Description



- 铝压铸灯体外壳，超白钢化玻璃
- 高透光PC透镜，具有高视觉舒适性和均匀配光透镜，供多种不同配光选择
- 高性能LED芯片，驱动有0-10V / DALI / 编程电源选择，20KV浪涌保护器
- 按钮式开启装置，打开无需工具
- 有竖装、横装和壁装三种安装方式，安装管径有Ø48 / Ø60mm
- 防紫外线聚氨酯粉末喷涂表面，盐雾测试可以达1000小时以上
- 无生物蓝光危害风险，符合EN62471: 2008标准
- 道路灯智能远程控制系统可选，可以与远程管理系统兼容
- 所有外部螺钉均为304不锈钢材质

- Die-casting aluminium body, super white tempered glass.
- Optics with PC lens with high visual comfortable and uniform lighting distribution, multiple light distribution options.
- High quality LED chips, Driver with 0-10V/DALI/programmed be options, and with surge protection up to 20KV.
- Tool-free replaceable with push-botton for opened device.
- There are three installation modes: vertical installation, horizontal installation and wall installation, installation tube diameter Ø48/Ø60mm.
- Surface anti-ultraviolet pure polyester powder painting, Corrosion resistance can be more than 1000 hours.
- No photo-biological risk, (no risk linked to infrared, blue light and UV radiation) in accordance with EN 62471:2008.
- Street lighting control used with smart control technology. It can be compatible with remote management system.
- All external screws are made of 304 stainless steel.

应用透镜 Optics application

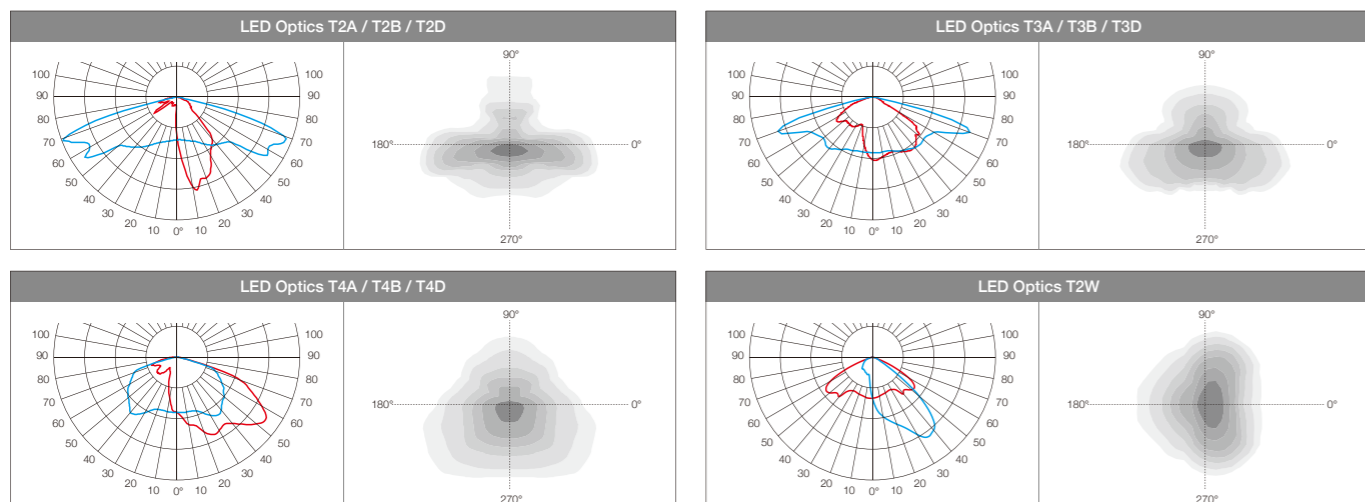

技术参数 Technology data

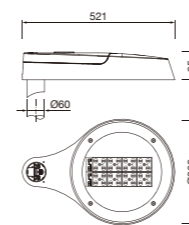

D-221S

Code	Power	LED Qty	Optics	Packing Size	Weight	Pcs/20"	Pcs/40"
LED chips - 3535/5050							
D-221SLED40-16	40W	16	T2A/T3A/T4A/T2M/T2W	500*370*135	6.2	1170	2465
D-221SLED40-32	40W	32	T2A/T3A/T4A/T2M/T2W	500*370*135	6.2	1170	2465
D-221SLED60-32	60W	32	T2A/T3A/T4A/T2M/T2W	500*370*135	6.2	1170	2465
D-221SLED75-32	75W	32	T2A/T3A/T4A/T2M/T2W	500*370*135	6.2	1170	2465

可选配件 Accessories options

	Code
横装转接头 Side-adptor	250000436
壁装底座 Wall bracket	210004479



D-200 Series



D-200M
75-150W

D-200S
25-60W

D-200L
150-240W

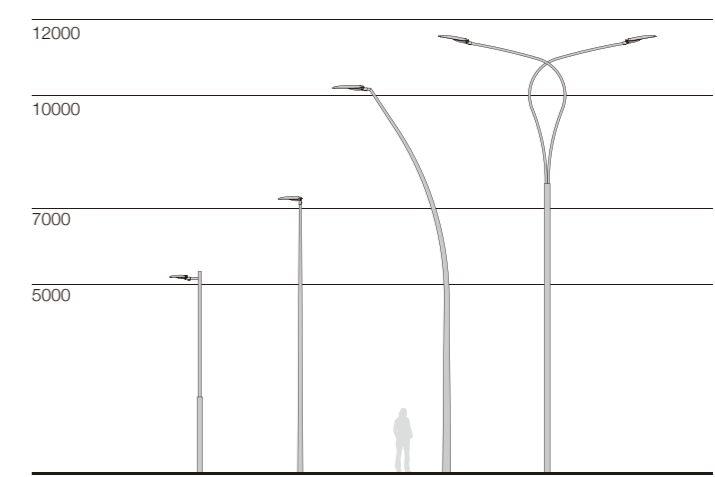



快捷拆卸式换灯结构，当灯具需要维修时，无需特殊工具，便可方便更换灯体部分

When the lighting needs to be repaired, the body can be easily replaced without special tools.



当灯具失效需要维修时，只需要拆卸更改灯体进行更换就可以，无需任何工具

When the lighting fails and needs to be repaired, it is only necessary to remove the body for replacement without any tools.

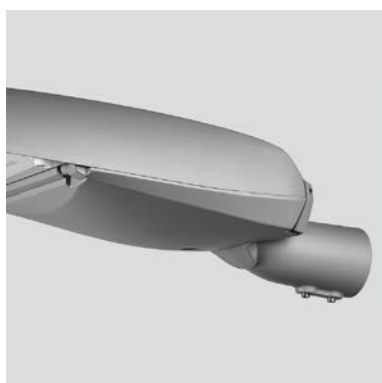

灯具具有横装、竖装二种方式，角度可以-15~+10度调节

Top or side fitting Ø60mm, Ø76 arm be option, from -15° ~ +10° angle adjustable.

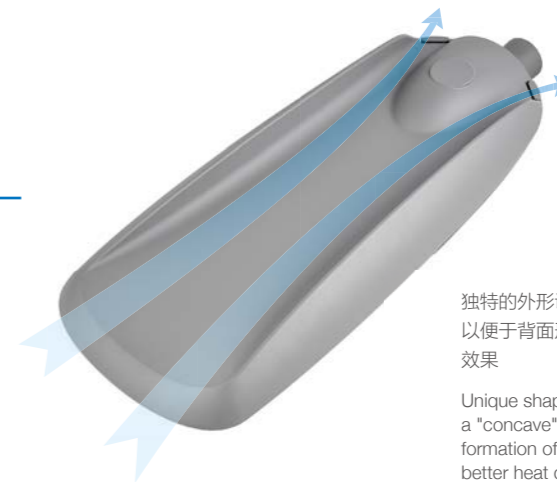

独特的外形设计，背部设计成“凹”型结构，以便于背面形成“风道”效应，能更好的散热效果

Unique shape design, the back is designed as a "concave" structure, to facilitate the formation of the back "air duct" effect, can better heat dissipation effect.



3 SIZES

LED

D-200 Series

一组高端极具设计感的LED道路灯，该灯具通过独特的外形设计，通过灯具背部设计凹型来增加风道效应，使结构最后达到快速散热的目的，体现设计者独具匠心的设计风格。

该系列灯具具有三个尺寸版本供应用选择，功率从25W-240W

A high-end LED road lighting, it with a strong sense of design, the lighting through the unique shape design and through the body back design concave to increase the wind effect, to achieve the purpose of heat dissipation structure. Reflect the designer's unique design style.

The series of lighting are available in three sizes, with power ranging from 25W to 240W.



IK08钢化玻璃罩，可适配Zhaga标准PCB板，模组式透镜供多种不同光型可选

IK08 tempered glass, it is suitable for zhaga standard PCB board. Modular lens is available for various light types.

简述 Description



- 铝压铸灯体外壳，超白钢化玻璃，特殊外形设计，有3种尺寸供选择
- 高透光PC透镜，具有高视觉舒适性和均匀配光透镜，供多种不同配光选择
- 高性能LED芯片，驱动有0-10V / DALI / 编程电源选择，20KV浪涌保护器
- 铝压铸扣攀开启方式，内设有开启断电保护器，灯体可以整体脱卸，维修更换方便
- 有侧装和顶装2种安装方式，角度可调，安装管径有 $\varnothing 48 / \varnothing 60 / \varnothing 76$ mm
- 防紫外线聚氨酯粉喷涂表面，盐雾测试可以达1000小时以上
- 无生物蓝光危害风险，符合EN62471: 2008标准
- 道路灯智能远程控制系统可选，可以与远程管理系统兼容
- 所有外部螺钉均为304不锈钢材质

- Die-casting aluminium body, super white tempered glass. Special shape design, it has 3 sizes version options.
- Optics with PC lens with high visual comfortable and uniform lighting distribution, multiple light distribution options.
- High quality LED chips, Driver with 0-10V/DALI/programmed be options, and with surge protection up to 20KV.
- Tool-free replaceable, die-casting fasten for opened device, automatic on/off connector when be open, The body can be detached and replaced easily.
- Top and side fixing, angle can be adjustable, installation tube diameter $\varnothing 48/\varnothing 60/\varnothing 76$ mm.
- Surface anti-ultraviolet pure polyester powder painting, Corrosion resistance can be more than 1000 hours.
- No photo-biological risk, (no risk linked to infrared, blue light and UV radiation) in accordance with EN 62471:2008.
- Street lighting control used with smart control technology. It can be compatible with remote management system.
- All external screws are made of 304 stainless steel.

应用透镜 Optics application

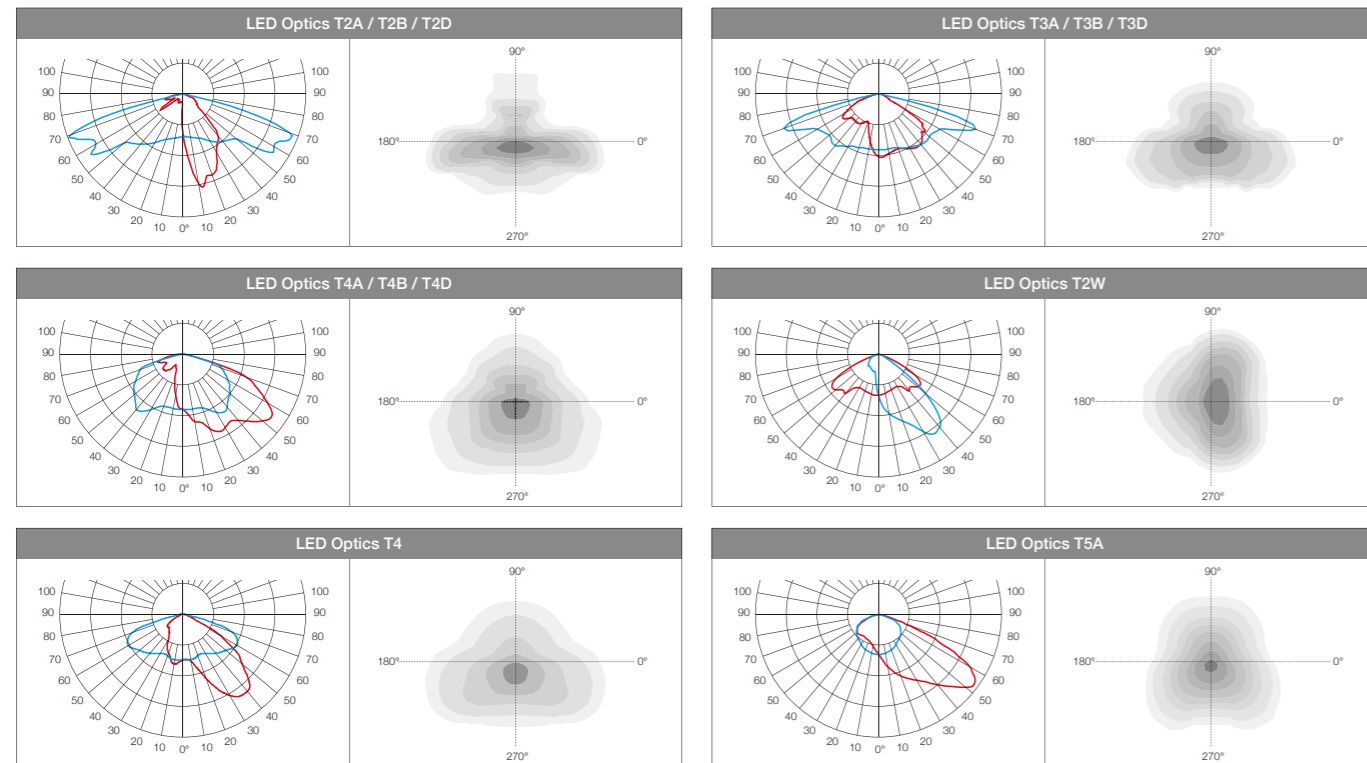

技术参数 Technology data

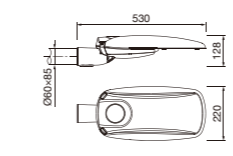
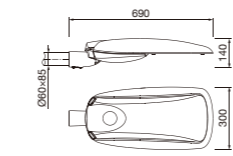
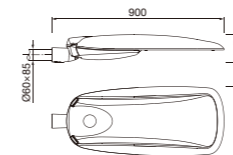

D-200L

Code	Power	LED Qty	Optics	Packing Size	Weight	Pcs/20"	Pcs/40"
LED chips - 3535/5050							
D-200LLED150-64	150W	64	T3A/T4A/T5A/T4	950*405*180	13.7	408	840
D-200LLED200-72	200W	72	T3A/T4A/T5A/T4	950*405*180	13.7	408	840
D-200LLED240-96	240W	96	T3A/T4A/T5A/T4	950*405*180	13.7	408	840

LED chips - 3030

D-200LLED200-224	200W	224	T2B/T3B/T4B	950*405*180	13.7	408	840
D-200LLED240-252	240W	252	T2B/T3B/T4B	950*405*180	13.7	408	840

D-200M

Code	Power	LED Qty	Optics	Packing Size	Weight	Pcs/20"	Pcs/40"
LED chips - 3535/5050							
D-200MLED75-32	75W	32	T2A/T3A/T4A/T2W/T4	735*340*165	8.0	624	1326
D-200MLED100-48	100W	48	T2A/T3A/T4A/T2W/T4	735*340*165	8.0	624	1326
D-200MLED120-48	120W	48	T2A/T3A/T4A/T2W/T4	735*340*165	8.0	624	1326
D-200MLED150-48	150W	48	T2A/T3A/T4A/T2W/T4	735*340*165	8.0	624	1326

LED chips - 3030

D-200MLED75-112	75W	112	T2B/T3B/T4B	735*340*165	8.0	624	1326
D-200MLED100-168	100W	168	T2B/T3B/T4B	735*340*165	8.0	624	1326
D-200MLED120-168	120W	168	T2B/T3B/T4B	735*340*165	8.0	624	1326
D-200MLED150-168	150W	168	T2B/T3B/T4B	735*340*165	8.0	624	1326

D-200S

Code	Power	LED Qty	Optics	Packing Size	Weight	Pcs/20"	Pcs/40"
LED chips - 3535/5050							
D-200SLED25-8	25W	8	T2A/T3A/T2W	565*230*150	6.8	1400	2912
D-200SLED40-16	40W	16	T2A/T3A/T2W	565*230*150	6.9	1400	2912
D-200SLED60-24	60W	24	T2D/T3D	565*230*150	6.9	1400	2912

LED chips - 3030

D-200SLED25-28	25W	28	T2B/T3B/T4B	565*230*150	6.8	1400	2912
D-200SLED50-56	50W	56	T2B/T3B/T4B	565*230*150	6.9	1400	2912

可选配件 Accessories options

		Code
	Ø76安装座 Fixing Arm	210001086
	Ø60安装座 Fixing Arm	210000255
	Ø60-48转换套 Adapter Arm / Adapter required for install on the pole.	210002547



D-212 Series



D-212L
120-180W



D-212S
40-100W



D-212SA
40-75W

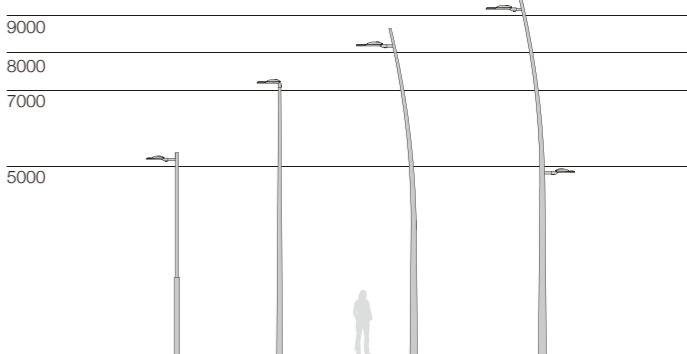



IP66电器腔室，灯具打开时有支撑杆防护和自动断电装置，有效保护灯具安全

IP66 electrical box housing, when the lighting open there is support rod protection and automatic power-off device to effectively protect the safety.



简洁的外形设计，配不锈钢扣攀设计，打开无需工具

Simple shape design, with stainless steel locker design, free tools to open.



D-212 Series

一组经济型LED路灯，功能齐全，造型简洁大方，从平凡中体现不平凡的设计理念。有玻璃罩和模组透镜二种光学模式，灯具功率范围从40W-180W。

A group of economic LED street lighting, with full complete functions and simple and generous modeling, reflects the extraordinary design concept from the ordinary. There are two optical modes: glass cover and module lens. The lamp power range is from 40W to 180W.



灯具具有横装、竖装二种方式，角度可以-10~+10度调节，安装座有Ø60 / Ø48mm供选择

Top or side fitting Ø60mm, Ø48 arm be option, from -10° ~ +10° angle adjustable.



每款尺寸灯具都配有钢化玻璃防护罩设计配置，IK09防护等级

Each type luminaire has equipped with tempered glass protective cover design configuration, IK09 protection level.



“SA”型尺寸灯具设有IP模组透镜配置选择，以满足个别客户注重高光效的需求

“SA” type luminaire is equipped with IP module lens configuration, it to meet individual customers demand for high light efficiency.

简述 Description



- 铝压铸灯体外壳，超白钢化玻璃
- 高透光PC透镜，具有高视觉舒适性和均匀配光透镜，供多种不同配光选择
- 高性能LED芯片，驱动有0-10V / DALI / 编程电源选择，20KV浪涌保护器
- 弹性不锈钢扣攀开启方式，设有开启断电保护器
- 有侧装和顶装2种安装方式，角度可调，安装管径有Ø48 / Ø60mm
- 防紫外线聚氨酯塑料喷涂表面，盐雾测试可达1000小时以上
- 无生物蓝光危害风险，符合EN62471: 2008标准
- 道路灯智能远程控制系统可选，可以与远程管理系统兼容
- 所有外部螺钉均为304不锈钢材质

- Die-casting aluminium body, super white tempered glass.
- Optics with PC lens with high visual comfortable and uniform lighting distribution, multiple light distribution options.
- High quality LED chips, Driver with 0-10V/DALI/programmed be options, and with surge protection up to 20KV.
- Tool-free replaceable, stainless steel fasten for opened device, automatic on/off connector when be open.
- Top and side fixing, angle can be adjustable, installation tube diameter Ø48/Ø60mm.
- Surface anti-ultraviolet pure polyester powder painting, Corrosion resistance can be more than 1000 hours.
- No photo-biological risk, (no risk linked to infrared, blue light and UV radiation) in accordance with EN 62471:2008.
- Street lighting control used with smart control technology. It can be compatible with remote management system.
- All external screws are made of 304 stainless steel.

应用透镜 Optics application

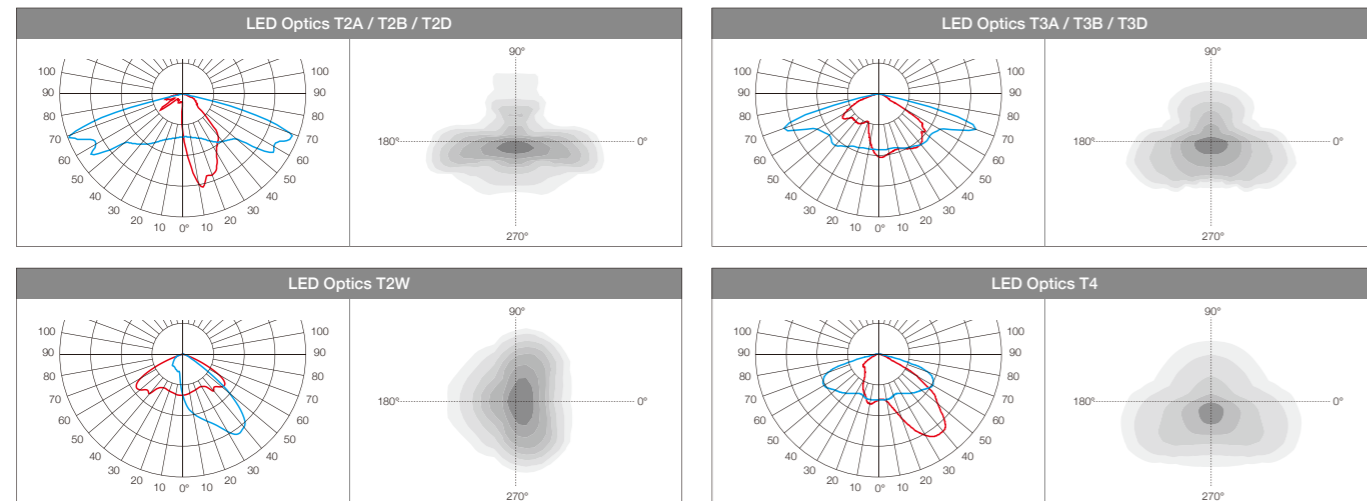

技术参数 Technology data

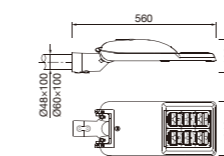
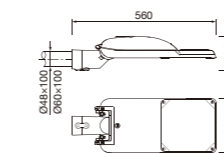
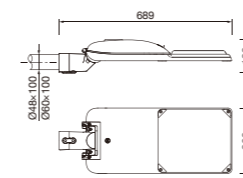

D-212L

Code	Power	LED Qty	Optics	Packing Size	Weight	Pcs/20"	Pcs/40"
LED chips - 3535/5050							
D-212LLED120-48	120W	48	T3A/T4A/T5A/T4	735*270*115	9.0	1170	2412
D-212LLED150-72	150W	72	T2D/T3D	735*270*115	9.0	1170	2412
D-212LLED180-72	180W	72	T2D/T3D	735*270*115	9.0	1170	2412

LED chips - 3030

D-212LLED150-168	150W	168	T2B/T3B/T4B	735*270*115	9.0	1170	2412
D-212LLED180-192	180W	192	T2B/T3B/T4B	735*270*115	9.0	1170	2412

D-212S

Code	Power	LED Qty	Optics	Packing Size	Weight	Pcs/20"	Pcs/40"
LED chips - 3535/5050							
D-212SLED40-24	40W	24	T3A/T4A/T2W/T4	590*220*110	5.0	1938	3933
D-212SLED60-24	60W	24	T3A/T4A/T2W/T4	590*220*110	5.0	1938	3933
D-212SLED75-36	75W	36	T2D/T3D	590*220*110	5.0	1938	3933
D-212SLED100-36	100W	36	T2D/T3D	590*220*110	5.0	1938	3933

LED chips - 3030

D-212SLED60-84	60W	84	T2B/T3B/T4B	590*220*110	5.0	1938	3933
D-212SLED75-84	75W	84	T2B/T3B/T4B	590*220*110	5.0	1938	3933

D-212SA

Code	Power	LED Qty	Optics	Packing Size	Weight	Pcs/20"	Pcs/40"
LED chips - 3535/5050							
D-212SALED40-24	40W	24	T12A	590*220*110	4.5	1938	3933
D-212SALED60-24	60W	24	T12A	590*220*110	4.5	1938	3933
D-212SALED75-24	75W	24	T12A	590*220*110	4.5	1938	3933

可选配件 Accessories options

	Code
Ø60安装座 Fixing Arm	210002620
Ø48安装座 Fixing Arm	210002621

Arm / Adapter required for install on the pole.





D-211-3M
150-180W

D-211-4M
200-240W



D-211-2M
75-120W

D-211-1M
40-60W

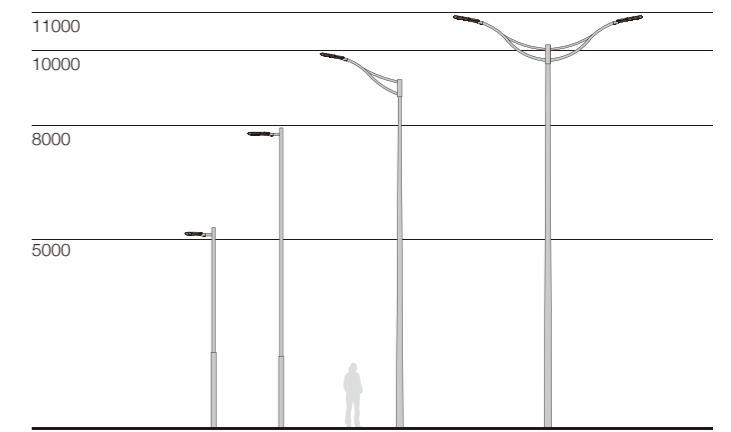

D-211 Series



IP66电器腔室，灯具打开时有支撑杆保护和自动断电装置，有效保护灯具安全

IP66 electrical box housing, when the lighting open there is support rod protection and automatic power-off device to effectively protect the safety.



模组配IP68组合式快插接头，接线方便安全，外加防尘装饰罩，美观实用

IP68 module is equipped with combined quick plug-in connector, which is convenient and safe for wiring, plus dust-proof decorative cover, beautiful and practical.



灯具结构采用模组形式，通过不同数量模组组合来实现不同需要功率

The structure adopts modular form, and different power requirements can be achieved through of module combinations.

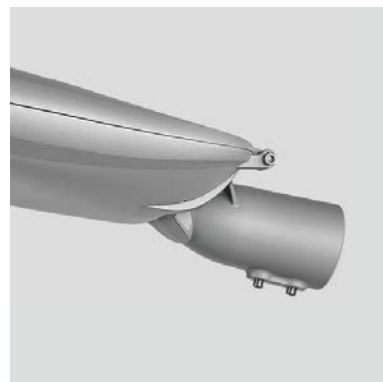

灯具具有横装、竖装二种方式，角度可以-15~+10度调节，安装座有Ø60 / Ø48mm供选择

Top or side fitting Ø60mm, Ø48 arm be option, from -15° ~ +10° angle adjustable.

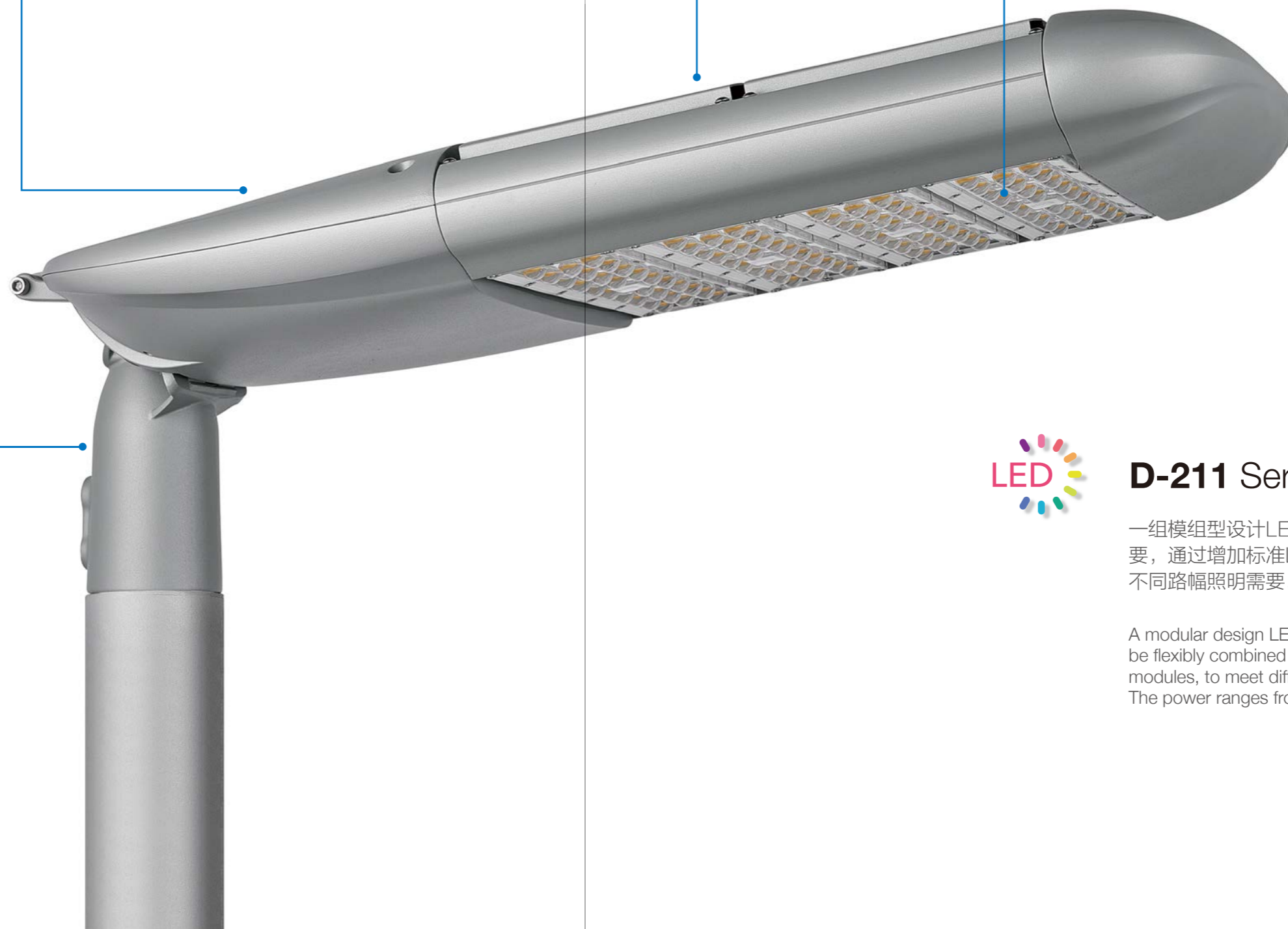

4
SIZES



D-211 Series

一组模组型设计LED路灯，灯具功率可以根据需要，通过增加标准LED模组来灵活组合，以适应不同路幅照明需要。灯具功率从40W-240W。

A modular design LED street lighting, the power can be flexibly combined by adding standard LED modules, to meet different road width lighting needs. The power ranges from 40W to 240W.



简述 Description



- 铝压铸灯体外壳，配标准光源模组，根据不同功率来组合光源模组
- 高透光PC透镜，具有高视觉舒适性和均匀配光透镜，供多种不同配光选择
- 高性能LED芯片，驱动有0-10V / DALI / 编程电源选择，20KV浪涌保护器
- 灯具电器箱IP67，设有开启断电保护器
- 有侧装和顶装2种安装方式，角度可调，安装管径有Ø48 / Ø60 / Ø76mm
- 防紫外线聚氨酯塑粉喷涂表面，盐雾测试可以达1000小时以上
- 无生物蓝光危害风险，符合EN62471: 2008标准
- 道路灯智能远程控制系统可选，可以与远程管理系统兼容
- 所有外部螺钉均为304不锈钢材质



MD-08 LED Module

- Die-casting aluminium body, with standare led moduler accoprding to be combined according to different power.
- Optics with PC lens with high visual comfortable and uniform lighting distribution, multiple light distribution options.
- High quality LED chips, Driver with 0-10V/DALI/programmed options, and with surge protection up to 20KV.
- IP67 electrical box, automatic on/off connector when be open.
- Top and side fixing, angle can be adjustable, installation tube diameter Ø48/Ø60/Ø76mm.
- Surface anti-ultraviolet pure polyester powder painting, Corrosion resistance can be more than 1000 hours.
- No photo-biological risk, (no risk linked to infrared, blue light and UV radiation) in accordance with EN 62471:2008.
- Street lighting control used with smart control technology. It can be compatible with remote management system.
- All external screws are made of 304 stainless steel.

应用透镜 Optics application

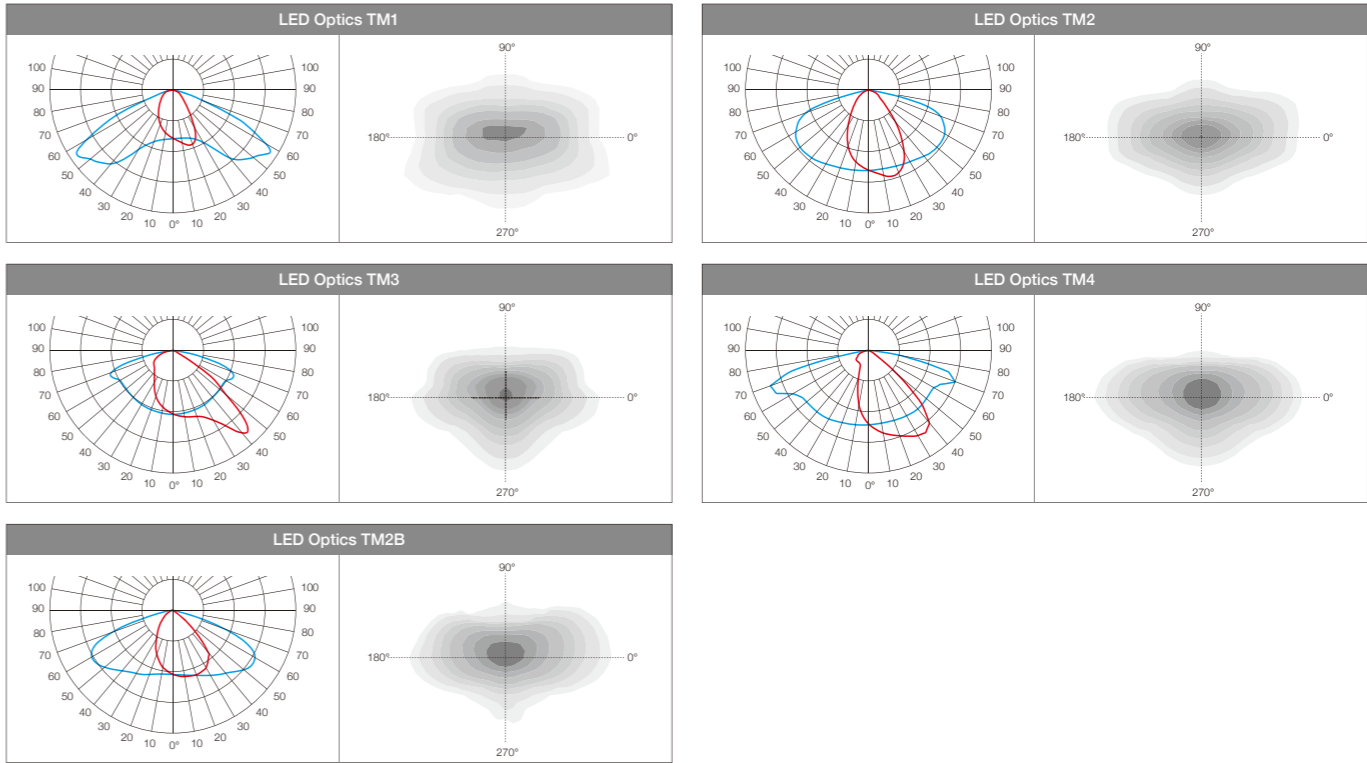

技术参数 Technology data



D-211-1M

Code	Power	LED Qty	Optics	Packing Size	Weight	Pcs/20"	Pcs/40"
LED chips - 5050							
D-211LED40-1M08D	40W	28	TM1/TM2/TM3/TM4	575*395*180	6.7	684	1440
D-211LED60-1M08D	60W	28	TM1/TM2/TM3/TM4	575*395*180	6.7	684	1440

LED chips - 3030

D-211LED40-1M08B	40W	66	TM2B	575*395*180	6.7	684	1440
D-211LED60-1M08B	60W	66	TM2B	575*395*180	6.7	684	1440

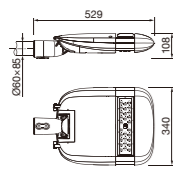

D-211-2M

Code	Power	LED Qty	Optics	Packing Size	Weight	Pcs/20"	Pcs/40"
LED chips - 5050							
D-211LED75-2M08D	75W	56	TM1/TM2/TM3/TM4	651*395*180	7.6	576	1224
D-211LED100-2M08D	100W	56	TM1/TM2/TM3/TM4	651*395*180	7.6	576	1224
D-211LED120-2M08D	120W	56	TM1/TM2/TM3/TM4	651*395*180	7.6	576	1224

LED chips - 3030

D-211LED75-2M08B	75W	132	TM2B	651*395*180	7.6	576	1224
D-211LED100-2M08B	100W	132	TM2B	651*395*180	7.6	576	1224
D-211LED120-2M08B	120W	132	TM2B	651*395*180	7.6	576	1224

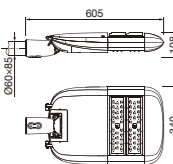

D-211-3M

Code	Power	LED Qty	Optics	Packing Size	Weight	Pcs/20"	Pcs/40"
LED chips - 5050							
D-211LED150-3M08D	150W	84	TM1/TM2/TM3/TM4	730*395*180	9.4	516	1104
D-211LED180-3M08D	180W	84	TM1/TM2/TM3/TM4	730*395*180	9.4	516	1104

LED chips - 3030

D-211LED150-3M08B	150W	198	TM2B	730*395*180	9.4	516	1104
D-211LED180-3M08B	180W	198	TM2B	730*395*180	9.4	516	1104

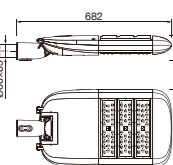

D-211-4M

Code	Power	LED Qty	Optics	Packing Size	Weight	Pcs/20"	Pcs/40"
LED chips - 5050							
D-211LED200-4M08D	200W	112	TM1/TM2/TM3/TM4	807*395*180	10.4	420	888
D-211LED240-4M08D	240W	112	TM1/TM2/TM3/TM4	807*395*180	10.4	420	888

LED chips - 3030

D-211LED200-4M08B	200W	264	TM2B	807*395*180	10.4	420	888
D-211LED240-4M08B	240W	264	TM2B	807*395*180	10.4	420	888

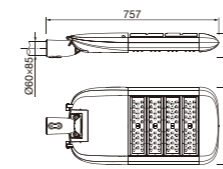

可选配件 Accessories options

		Code
	Ø76安装座 Fixing Arm	210001086
	Ø60安装座 Fixing Arm	210000255
	Ø60-48转换套 Adapter Arm / Adapter required for install on the pole.	210002547



D-210

KLED



D-210
75-180W

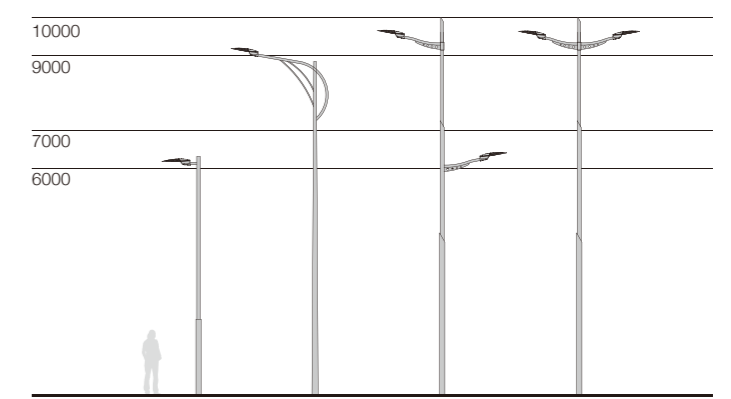

简述 Description



- 铝压铸灯体外壳，超白钢化玻璃
- 高透光PC透镜，具有高视觉舒适性和均匀配光透镜，供多种不同配光选择
- 高性能LED芯片，驱动有0-10V / DALI / 编程电源选择，20KV浪涌保护器
- 定制快速开启螺钉配置，内设有开启断电保护器
- 有侧装和顶装2种安装方式，角度可调，安装管径有Ø48 / Ø60mm
- 防紫外线聚氨酯粉末喷涂表面，盐雾测试可以达1000小时以上
- 无生物蓝光危害风险，符合EN62471: 2008标准
- 道路灯智能远程控制系统可选，可以与远程管理系统兼容
- 所有外部螺钉均为304不锈钢材质

- Die-casting aluminium body, super white tempered glass.
- Optics with PC lens with high visual comfortable and uniform lighting distribution, multiple light distribution options.
- High quality LED chips, Driver with 0-10V/DALI/programmed options, and with surge protection up to 20KV.
- Tool-free replaceable, special screw for opened device, automatic on/off connector when be open.
- Top and side fixing, angle can be adjustable, installation tube diameter Ø48/Ø60mm.
- Surface anti-ultraviolet pure polyester powder painting, Corrosion resistance can be more than 1000 hours.
- No photo-biological risk, (no risk linked to infrared, blue light and UV radiation) in accordance with EN 62471:2008.
- Street lighting control used with smart control technology. It can be compatible with remote management system.
- All external screws are made of 304 stainless steel.

应用透镜 Optics application

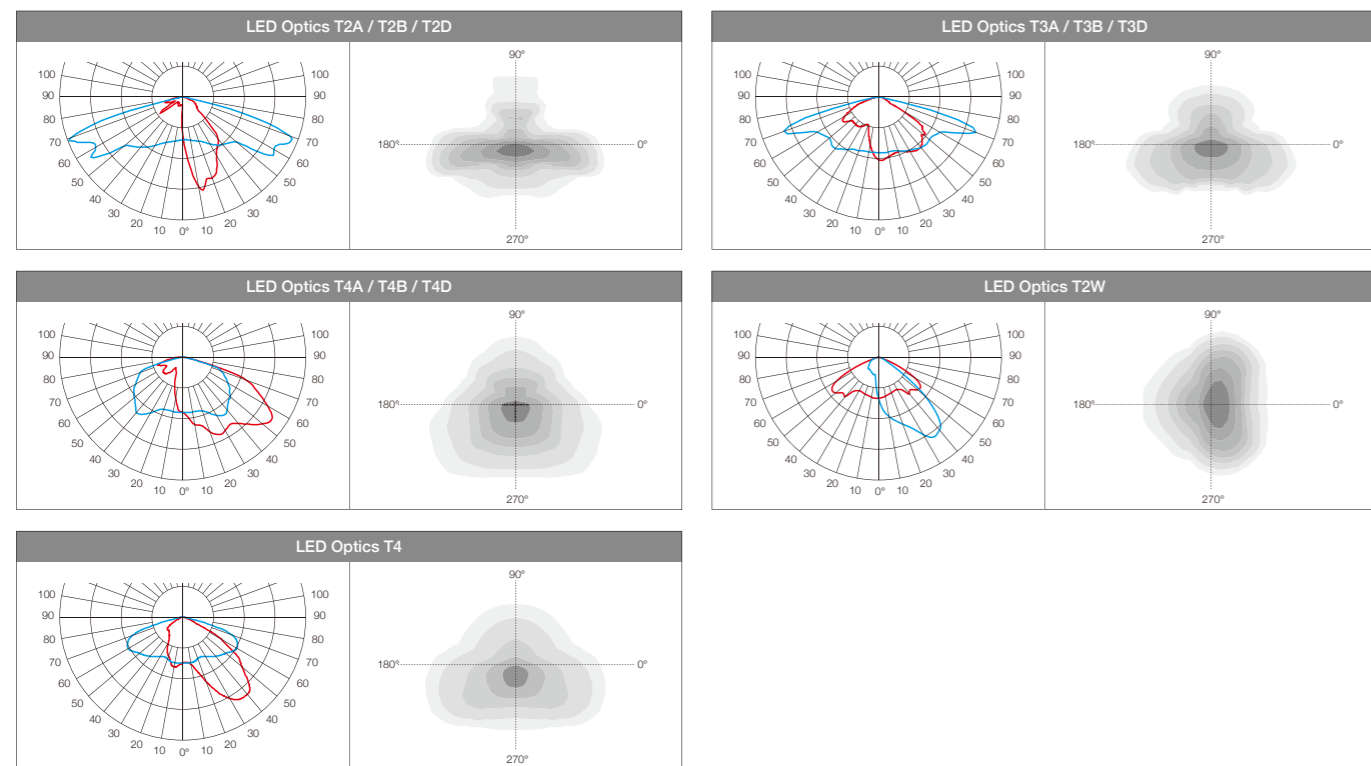

技术参数 Technology data

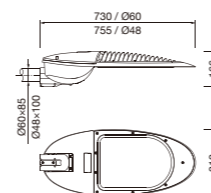

D-210

Code	Power	LED Qty	Optics	Packing Size	Weight	Pcs/20"	Pcs/40"
LED chips - 3535/5050							
D-210LED75-32	75W	32	T3A/T4A/T5A/T4/T2W	780*330*190	9.0	528	1100
D-210LED100-32	100W	32	T3A/T4A/T5A/T4/T2W	780*330*190	9.0	528	1100
D-210LED120-48	120W	48	T3A/T4A/T5A/T4	780*330*190	9.0	528	1100
D-210LED150-48	150W	48	T3A/T4A/T5A/T4	780*330*190	9.0	528	1100
D-210LED180-72	180W	72	T2D/T3D/T4D	780*330*190	9.0	528	1100
LED chips - 3030							
D-210LED100-112	100W	112	T2B/T3B/T4B	780*330*190	9.0	528	1100
D-210LED150-168	150W	168	T2B/T3B/T4B	780*330*190	9.0	528	1100



IK09钢化玻璃罩，可适配Zhaga标准PCB板，模组式透镜供多种不同光型可选
IK09 tempered glass, it is suitable for zhaga standard PCB board. Modular lens is available for various light types.



IP66电器腔室，可以接入智能照明控制实现节能，免工具打开装置设计
IP66 electrical housing, it can be install dimming control system to saving engine, free tooling to open.



流线型灯具外形设计，顶部设置有NEMA标准插座，可连接智慧城市控制和管理系统
Streamlined lighting shape design, with NEMA standard socket on the top, which can be connected with smart city.

可选配件 Accessories options

	Code
Ø60安装座 Fixing Arm	210000218
Ø48安装座 Fixing Arm	210001039

Arm / Adapter required for install on the pole.





T-202SS
30-75W

D-202MH
100-150W

D-202SH
30-75W



D-202MS
100-150W

D-202SS
60-75W



一组多功能组合式庭院式路灯，通过不同的支架连接，达到不同的变化效果，来适应不同照明场所的需求，被广泛使用在庭院、小区、公园、步行街等场所。灯具功率范围为30W-150W。

A group of multi-functional street lighting are connected by different brackets to achieve different effects, so as to suit of different area places. It be widely used in courtyards, residential areas, parks, pedestrian streets and other places. The power range is 30W-150W.

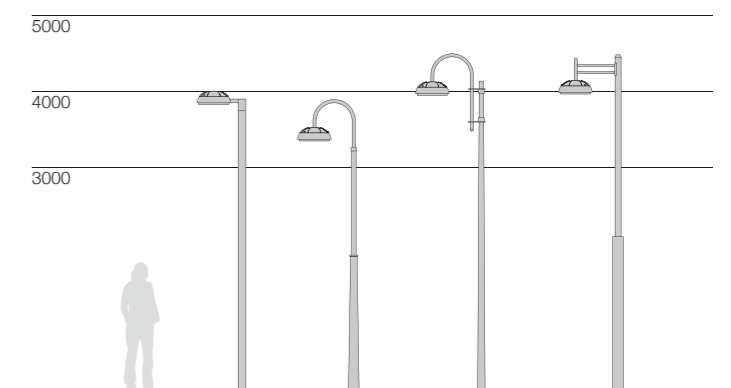

D-202 / T-202 Series

简述 Description

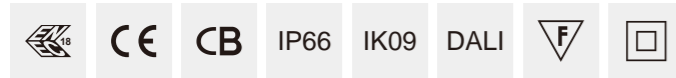

- 铝压铸灯体外壳，超白钢化玻璃，特殊外形设计，有2种尺寸供选择
- 高透光PC透镜，多种光学组件可选，具有高视觉舒适性和防眩效果
- 高性能LED芯片，驱动有ON-OFF / 0-10V / DALI / 编程电源选择，20KV浪涌保护器
- 灯具不同支架选项，可根据需要选配适用在不同场所
- 防紫外线聚氨酯粉末喷涂表面，耐腐蚀可以达1000小时以上
- 无生物蓝光危害风险，符号EN62471: 2008标准
- 所有外部螺钉均为304不锈钢材质

- Die-casting aluminium body, super white tempered glass. Special shape design, it has 2 sizes version options.
- Optics with PC lens with high visual comfortable and good anti glare effect, multiple light distribution options.
- High quality LED chips, with ON-OFF/0-10V/DALI/programmed be options, and with surge protection up to 20KV.
- The luminaire have multiple brackets to option, it can suit different application.
- Surface anti-ultraviolet pure polyester powder painting, Corrosion resistance can be more than 1000 hours.
- No photo-biological risk, in accordance with EN 62471:2008.
- All external screws are made of 304 stainless steel.

应用透镜 Optics application

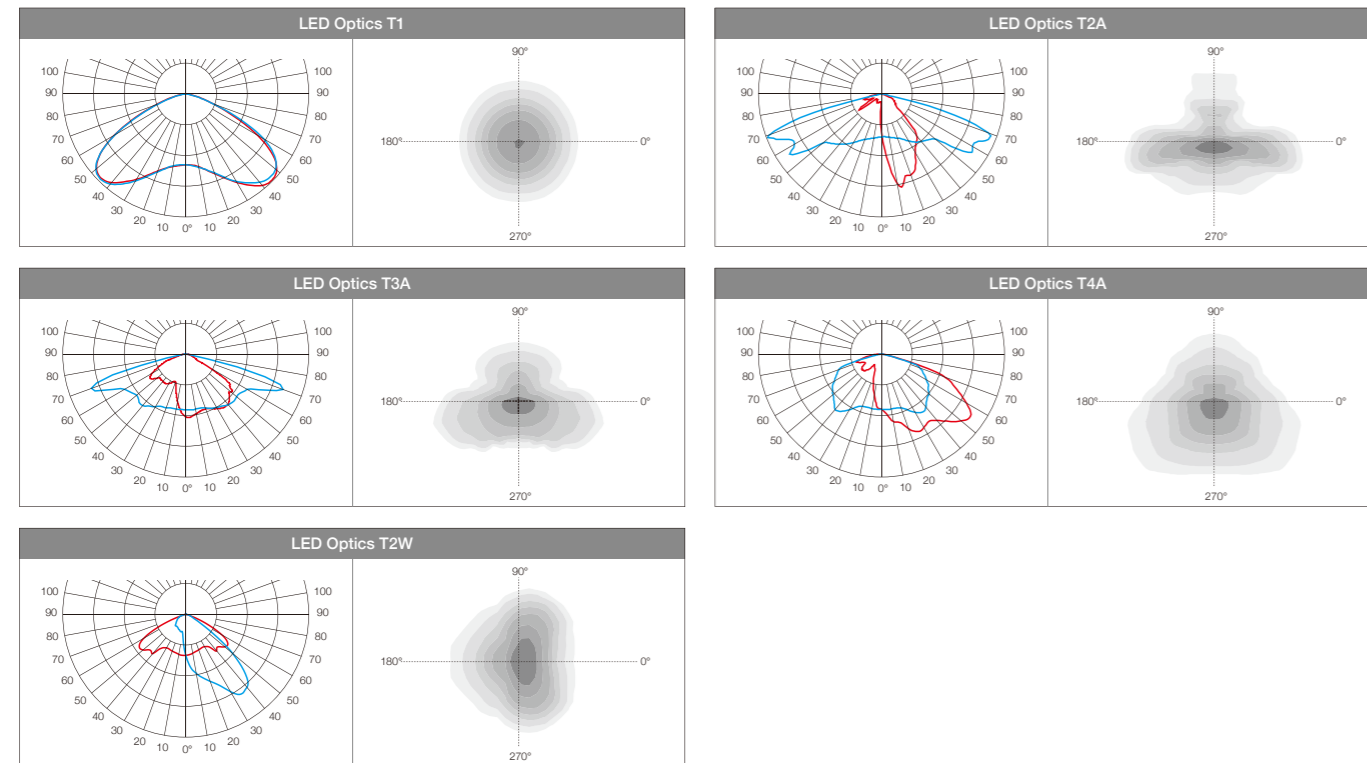

技术参数 Technology data



D-202MH

Code	Power	LED Qty	Optics	Packing Size	Weight	Pcs/20"	Pcs/40"
LED chips - 3535/5050							
D-202MHLED100-48	100W	48	T1/T2A/T3A/T4A	545*450*215	11.0	530	1080
D-202MHLED120-48	120W	48	T1/T2A/T3A/T4A	545*450*215	11.0	530	1080
D-202MHLED150-64	150W	64	T1/T2A/T3A/T4A	545*450*215	11.5	530	1080

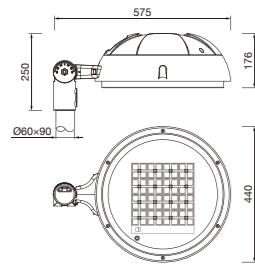

D-202SH

Code	Power	LED Qty	Optics	Packing Size	Weight	Pcs/20"	Pcs/40"
LED chips - 3535/5050							
D-202SHLED30-24	30W	24	T1/T2A/T3A/T4A/T2W	460*355*205	7.5	780	1610
D-202SHLED40-24	40W	24	T1/T2A/T3A/T4A/T2W	460*355*205	7.5	780	1610
D-202SHLED60-24	60W	24	T1/T2A/T3A/T4A/T2W	460*355*205	7.6	780	1610
D-202SHLED75-24	75W	24	T1/T2A/T3A/T4A/T2W	460*355*205	7.6	780	1610

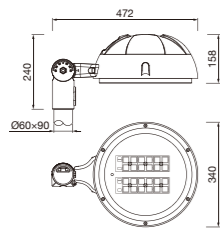

T-202SS

Code	Power	LED Qty	Optics	Packing Size	Weight	Pcs/20"	Pcs/40"
LED chips - 3535/5050							
T-202SSLED30-24	30W	24	T1/T2A/T3A/T4A/T2W	350*350*180	6.0	1152	2448
T-202SSLED40-24	40W	24	T1/T2A/T3A/T4A/T2W	350*350*180	6.0	1152	2448
T-202SSLED60-24	60W	24	T1/T2A/T3A/T4A/T2W	350*350*180	6.1	1152	2448
T-202SSLED75-24	75W	24	T1/T2A/T3A/T4A/T2W	350*350*180	6.1	1152	2448

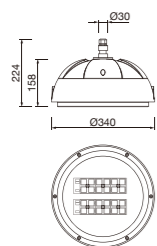

D-202MS

Code	Power	LED Qty	Optics	Packing Size	Weight	Pcs/20"	Pcs/40"
LED chips - 3535/5050							
D-202MSLED100-48	100W	48	T1/T2A/T3A/T4A	450*450*200	7.5	660	1430
D-202MSLED120-48	120W	48	T1/T2A/T3A/T4A	450*450*200	7.5	660	1430
D-202MSLED150-64	150W	64	T1/T2A/T3A/T4A	450*450*200	7.5	660	1430

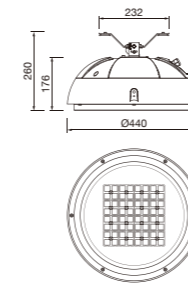

D-202SS

Code	Power	LED Qty	Optics	Packing Size	Weight	Pcs/20"	Pcs/40"
LED chips - 3535/5050							
D-202SSLED60-24	60W	24	T1/T2A/T3A/T4A/T2W	350*350*180	6.5	1152	2448
D-202SSLED75-36	75W	36	T1/T2A/T3A/T4A/T2W	350*350*180	6.6	1152	2448

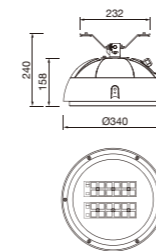

延伸产品 More in family



TG-202M / TG-202S

Flood Lighting: 75~240W.



F-202M / F-202S

Highbay Lighting: 75~240W.



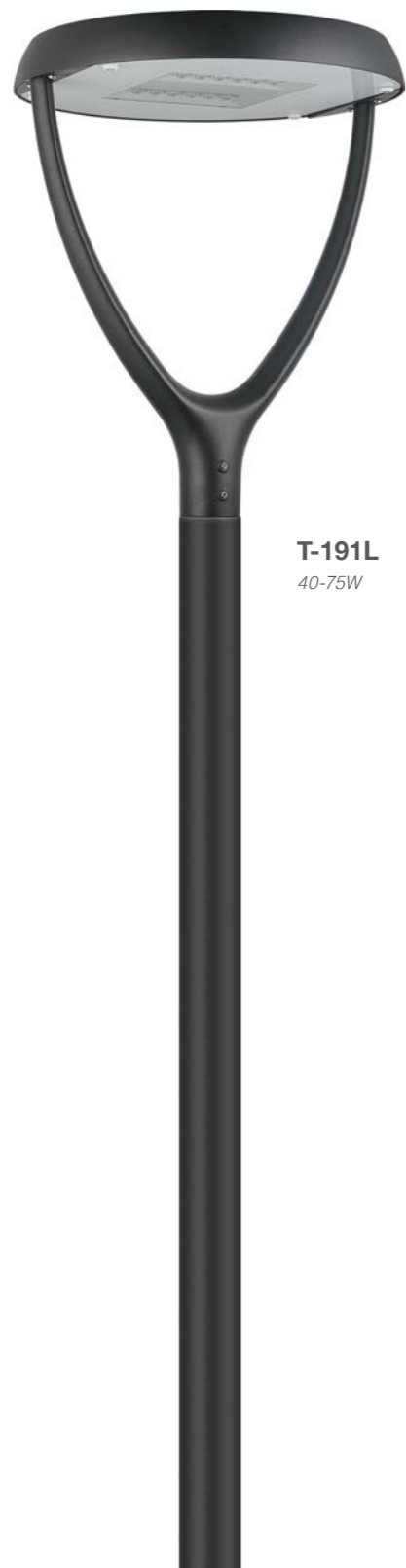

T-191L
40-75W

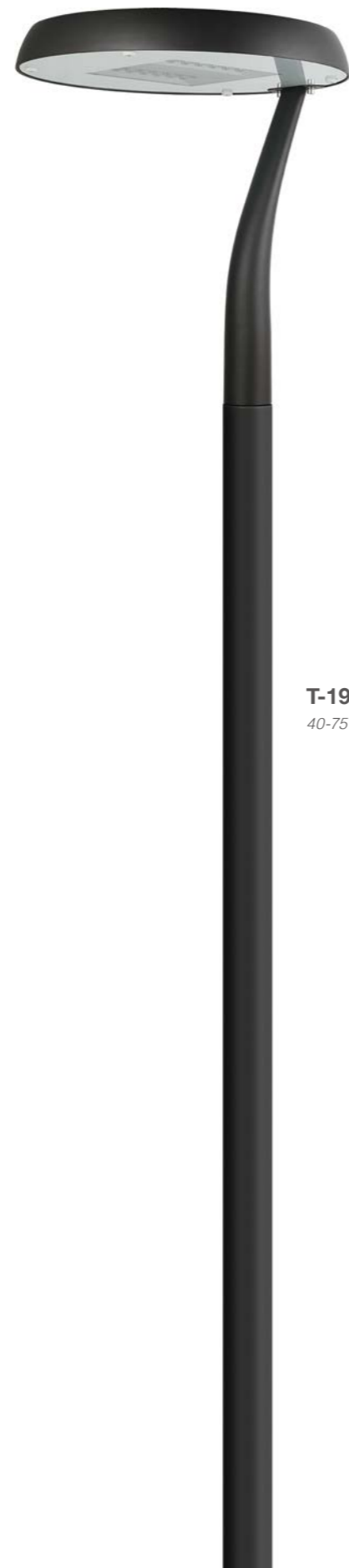

T-191P
40-75W



D-191H
40-75W



D-191S
40-75W



一组融入现代设计元素的经典LED庭院灯具，灯具设计有多种安装支架，通过更换不同安装支架来达到不同视觉效果，可以广泛应用在广场、公园、小区等场合。灯具功率从40W-75W。

A modern design of classic LED garden lighting, which design has a variety of mounting bracket, through the replacement of different mounting bracket to achieve different visual effect, it can be widely used in square, park, community and other occasions. The power is from 40W to 75W.

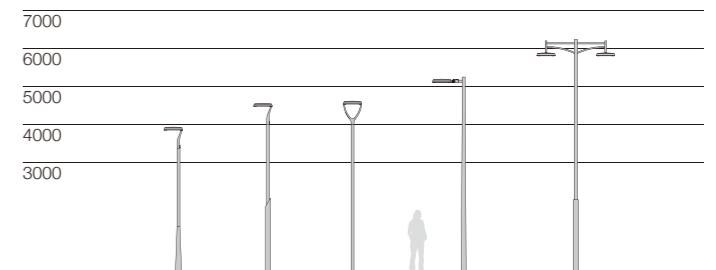



简述 Description



- 铝压铸灯体外壳，超白钢化玻璃，白色塑料反射罩
- 高透光PC透镜，具有高视觉舒适性和均匀配光透镜，供多种不同配光选择
- 高性能LED芯片，驱动有0-10V / DALI / 编程电源选择，20KV浪涌保护器
- 有多种安装支架供选择搭配，形成多款不同外形灯具
- 有侧装和顶装2种安装方式，角度可调，安装管径有 $\varnothing 60 / \varnothing 76\text{mm}$
- 防紫外线聚氨酯粉末喷涂表面，盐雾测试可以达1000小时以上
- 无生物蓝光危害风险，符合EN62471: 2008标准
- 道路灯智能远程控制系统可选，可以与远程管理系统兼容
- 所有外部螺钉均为304不锈钢材质

- Die-casting aluminium body, super white tempered glass, white PC plastic reflector.
- Optics with PC lens with high visual comfortable and uniform lighting distribution, multiple light distribution options.
- High quality LED chips, Driver with 0-10V/DALI/programmed be options, and with surge protection up to 20KV.
- There are a variety of mounting brackets options, form of different shapes of lightng.
- Top and side fixing, angle can be adjustable, installation tube diameter $\varnothing 60 / \varnothing 76\text{mm}$.
- Surface anti-ultraviolet pure polyester powder painting, Corrosion resistance can be more than 1000 hours.
- No photo-biological risk, (no risk linked to infrared, blue light and UV radiation) in accordance with EN 62471:2008.
- Street lighting control used with smart control technology. It can be compatible with remote management system.
- All external screws are made of 304 stainless steel.

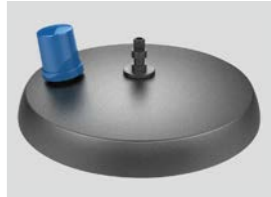
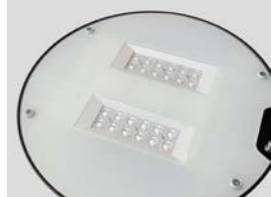

应用透镜 Optics application

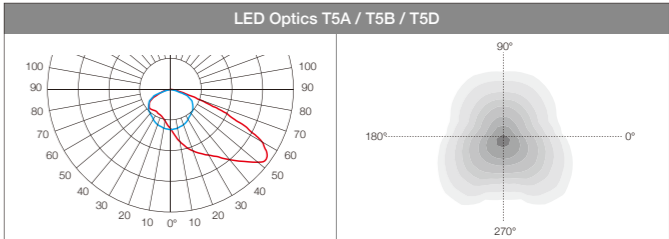
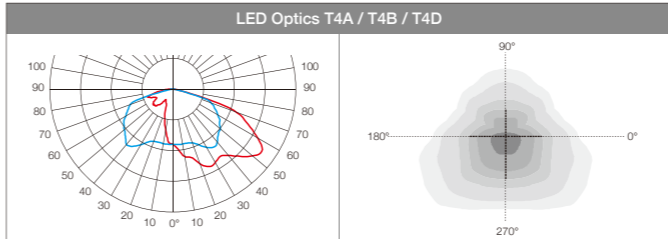
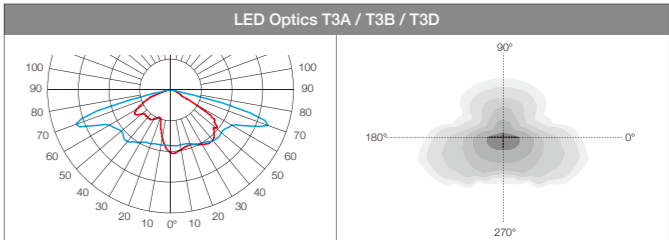
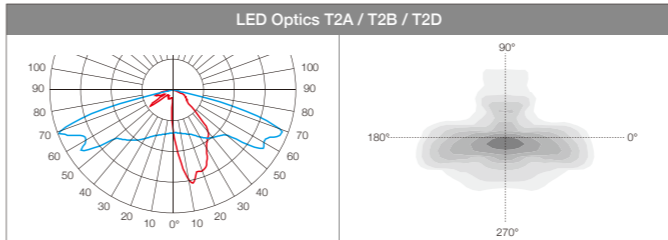

技术参数 Technology data



T-191L

Code	Power	LED Qty	Optics	Packing Size	Weight	Pcs/20"	Pcs/40"
LED chips - 3535/5050							
T-191LLED40-16 A4	40W	16	T1A/T2A/T3A/T4A	580*530*190	12.5	440	946
T-191LLED60-24 A2	60W	24	T1A/T2A/T3A/T4A	580*530*190	12.5	440	946
T-191LLED75-36 D2	75W	36	T1D/T2D/T3D/T4D	580*530*190	12.5	440	946

LED chips - 3030

T-191LLED40-56 B4	40W	56	T1B/T2B/T3B/T4B	580*530*190	12.5	440	946
T-191LLED60-84 B2	60W	84	T1B/T2B/T3B/T4B	580*530*190	12.5	440	946

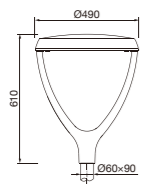

T-191P

Code	Power	LED Qty	Optics	Packing Size	Weight	Pcs/20"	Pcs/40"
LED chips - 3535/5050							
T-191PLED40-16 A4	40W	16	T1A/T2A/T3A/T4A	550*510*115	9.7	792	1656
T-191PLED60-24 A2	60W	24	T1A/T2A/T3A/T4A	550*510*115	9.7	792	1656
T-191PLED75-36 D2	75W	36	T1D/T2D/T3D/T4D	550*510*115	9.7	792	1656

LED chips - 3030

T-191PLED40-56 B4	40W	56	T1B/T2B/T3B/T4B	550*510*115	9.7	792	1656
T-191PLED60-84 B2	60W	84	T1B/T2B/T3B/T4B	550*510*115	9.7	792	1656

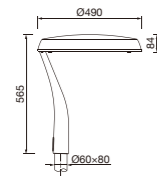

D-191H

Code	Power	LED Qty	Optics	Packing Size	Weight	Pcs/20"	Pcs/40"
LED chips - 3535/5050							
D-191HLED40-16 A4	40W	16	T1A/T2A/T3A/T4A	540*505*115	9.0	792	1656
D-191HLED60-24 A2	60W	24	T1A/T2A/T3A/T4A	540*505*115	9.0	792	1656
D-191HLED75-36 D2	75W	36	T1D/T2D/T3D/T4D	540*505*115	9.0	792	1656

LED chips - 3030

D-191HLED40-56 B4	40W	56	T1B/T2B/T3B/T4B	540*505*115	9.0	792	1656
D-191HLED60-84 B2	60W	84	T1B/T2B/T3B/T4B	540*505*115	9.0	792	1656

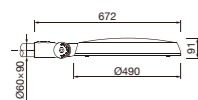

D-191S

Code	Power	LED Qty	Optics	Packing Size	Weight	Pcs/20"	Pcs/40"
LED chips - 3535/5050							
D-191SLED40-16 A4	40W	16	T1A/T2A/T3A/T4A	500*500*125	8.3	748	1564
D-191SLED60-24 A2	60W	24	T1A/T2A/T3A/T4A	500*500*125	8.3	748	1564
D-191SLED75-36 D2	75W	36	T1D/T2D/T3D/T4D	500*500*125	8.3	748	1564

LED chips - 3030

D-191SLED40-56 B4	40W	56	T1B/T2B/T3B/T4B	500*500*125	8.3	748	1564
D-191SLED60-84 B2	60W	84	T1B/T2B/T3B/T4B	500*500*125	8.3	748	1564

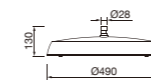

可选配件 Accessories options

	Code
Ø60-76转接头 Pole reducer	210001465
Required for install on the pole.	

延伸产品 More in family

SOLAR OPTIONS



TS-191L

Solar Lighting: 12W.



TS-191P

Solar Lighting: 12W.





T-190B
30-60W

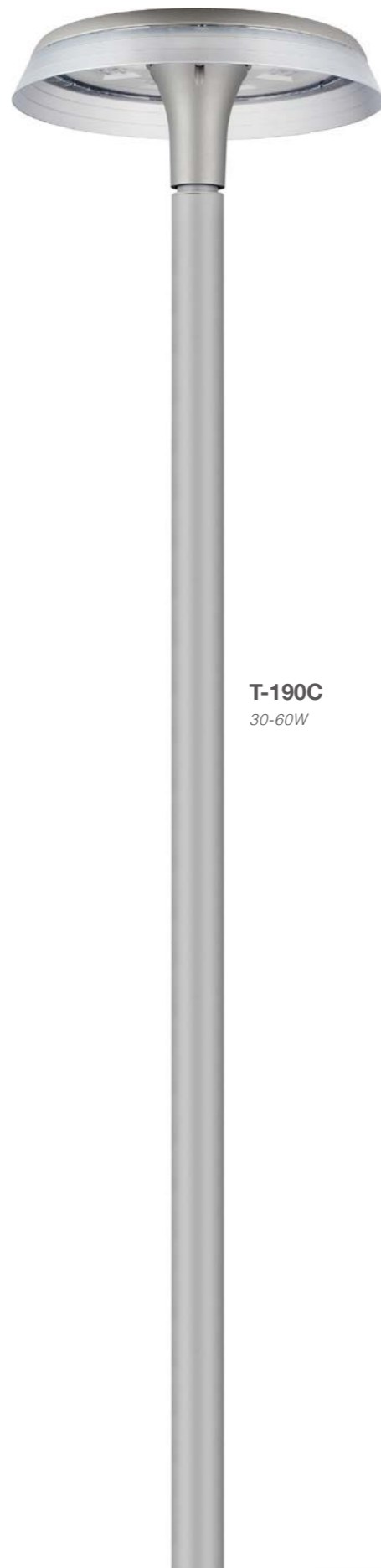

T-190C
30-60W

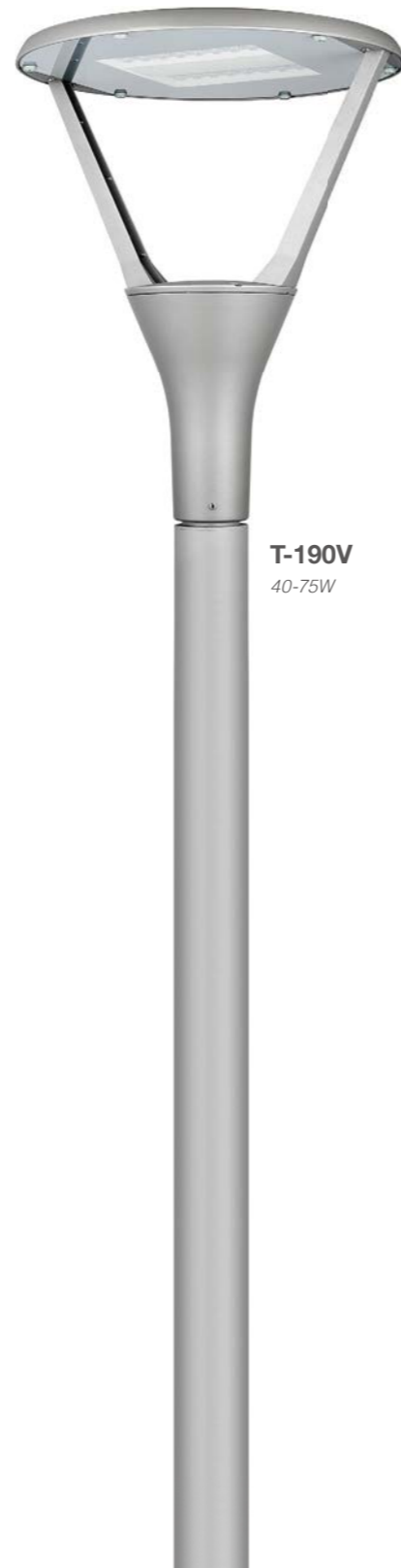

T-190V
40-75W

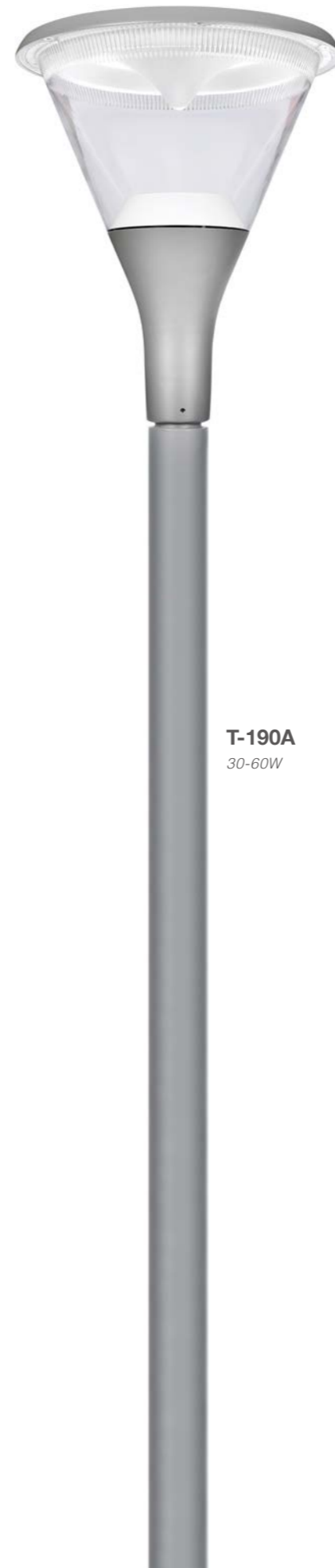

T-190A
30-60W



T-190N
40-60W



突发的灵感，整体的构思，借助于设计师专业的对光应用的智慧，造就了本系列LED庭院灯具的传奇。将光的舒适性和光亮度的技术融合，全都诠释在该系列灯具之中。

The sudden inspiration, overall idea, with the help of the designer's professional wisdom of light application, has created the legend of this series of LED courtyard lighting. From the light comfort and brightness of different understanding, all interpretation in it.

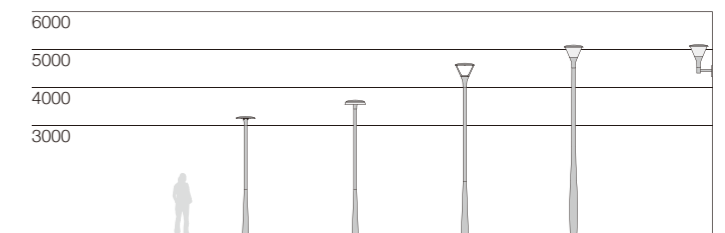

T-190B



360度圆周发光 / 360° distribution light



雾状扩散罩 / Flog diffuser



T-190C



增加雾状透明装, 有效防止眩光
New add flog diffuser to light more smooth.



T-190A



光线从底部向上投射, 通过上反射罩把光线均匀照射路面 —— 光线更柔和

Light from bottom to up, The light is projected upward from the bottom, through the upper reflector to illuminate — Light more smooth.

T-190N



光线直接从上面直接向下照明 —— 光效更高

Light goes straight down from upper — Higher light efficiency.

T-190 Series

简述 Description



- 铝压铸灯体外壳，超白钢化玻璃
- 高透光PC透镜，具有高视觉舒适性和均匀配光透镜，供多种不同配光选择
- 高性能LED芯片，驱动有0-10V / DALI / 编程电源选择，20KV浪涌保护器
- 有多种安装支架供选择搭配，形成多款不同外形灯具，安装管径有 $\varnothing 60 / \varnothing 76\text{mm}$
- 根据不同客户对光的需要，有光直射和间接反射供选择
- 防紫外线聚氨酯粉末喷涂表面，盐雾测试可以达1000小时以上
- 无生物蓝光危害风险，符合EN62471: 2008标准
- 道路灯智能远程控制系统可选，可以与远程管理系统兼容
- 所有外部螺钉均为304不锈钢材质

- Die-casting aluminium body, super white tempered glass. Anti aging PC plastic diffuser.
- Optics with PC lens with high visual comfortable and uniform lighting distribution, multiple light distribution options.
- High quality LED chips, Driver with 0-10V/DALI/programmed be options, and with surge protection up to 20KV.
- There are a variety of mounting brackets options, form of different shapes of lighting, installation tube diameter $\varnothing 60/\varnothing 76\text{mm}$.
- There are direct light and indirect reflection to options for different clients demand.
- Surface anti-ultraviolet pure polyester powder painting, Corrosion resistance can be more than 1000 hours.
- No photo-biological risk, (no risk linked to infrared, blue light and UV radiation) in accordance with EN 62471:2008.
- Street lighting control used with smart control technology. It can be compatible with remote management system.
- All external screws are made of 304 stainless steel.

应用透镜 Optics application

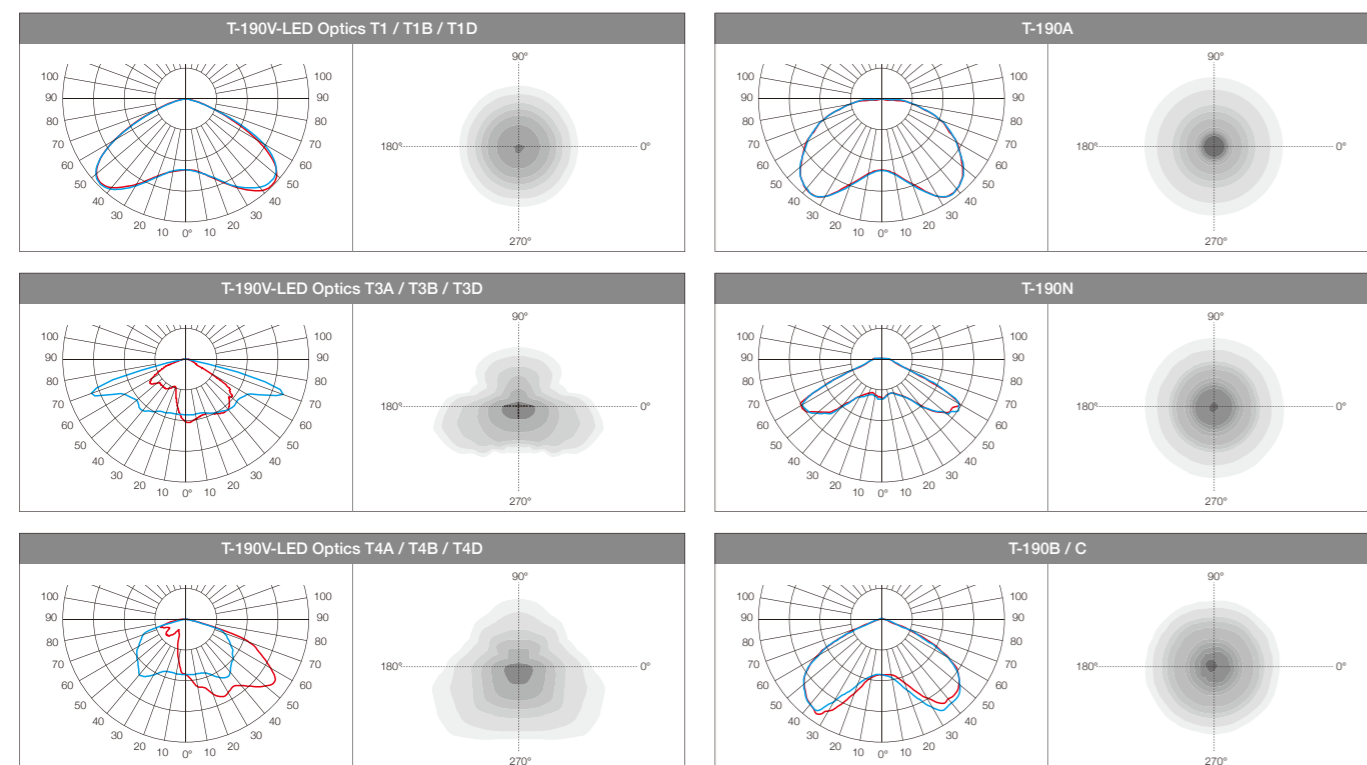

技术参数 Technology data



T-190A

Code	Power	LED Qty	Optics	Packing Size	Weight	Pcs/20"	Pcs/40"
LED chips - 3535/5050							
T-190ALE30-24	30W	24	T25A	510*510*660	9.0	132	276
T-190ALE40-24	40W	24	T25A	510*510*660	9.0	132	276
T-190ALE60-24	60W	24	T25A	510*510*660	9.0	132	276

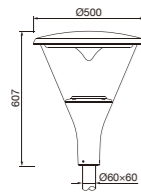

T-190N

Code	Power	LED Qty	Optics	Packing Size	Weight	Pcs/20"	Pcs/40"
LED chips - 2835							
T-190N1LED40-128	40W	128	T32B	510*510*580	9.0	176	368
T-190N1LED60-128	60W	128	T32B	510*510*580	9.0	176	368

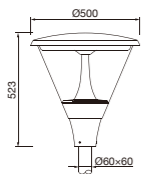

T-190B

Code	Power	LED Qty	Optics	Packing Size	Weight	Pcs/20"	Pcs/40"
LED chips - 3535/5050							
T-190BLE40-32	40W	32	T1/T90	570*570*285	10.0	280	560
T-190BLE60-32	60W	32	T1/T90	570*570*285	10.0	280	560

LED chips - 3030

T-190BLE30-32	30W	32	T1/T90	570*570*285	10.0	280	560
T-190BLE40-48	40W	48	T1D/T90D	570*570*285	10.0	280	560

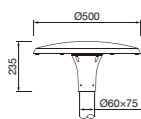

T-190C

Code	Power	LED Qty	Optics	Packing Size	Weight	Pcs/20"	Pcs/40"
LED chips - 3535/5050							
T-190CLE40-32	40W	32	T1/T90	570*570*285	10.5	280	560
T-190CLE60-32	60W	32	T1/T90	570*570*285	10.5	280	560

LED chips - 3030

T-190CLE30-32	30W	32	T1/T90	570*570*285	10.5	280	560
T-190CLE40-48	40W	48	T1D/T90D	570*570*285	10.5	280	560

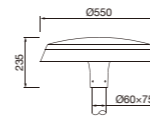

T-190V

Code	Power	LED Qty	Optics	Packing Size	Weight	Pcs/20"	Pcs/40"
LED chips - 3535/5050							
T-190VLED40-16 A5	40W	16	T1/T3A/T4A	510*510*405	11.6	220	460
T-190VLED60-32 A3	60W	32	T1/T3A/T4A	510*510*405	11.6	220	460

LED chips - 3030

T-190VLED40-56 B5	40W	56	T1B/T3B/T4B	510*510*405	11.6	220	460
T-190VLED75-112 B3	75W	112	T1B/T3B/T4B	510*510*405	11.6	220	460

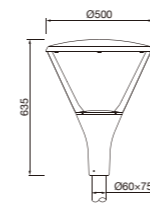

可选配件 Accessories options

	Code
Ø60-76转接头 Pole reducer Required for install on the pole.	210001465
壁装支架 Wall bracket	220001236



D-180M
75-150W



D-180S
25-60W

2
SIZES



一组经济型实用型路灯，造型简洁，功能齐全，能满足各种道路照明需要，灯具功率从25W-150W。

An economical and practical street lighting, simple in shape and complete in function, can meet the needs of various road lighting, with lamp power from 25W to 150W.

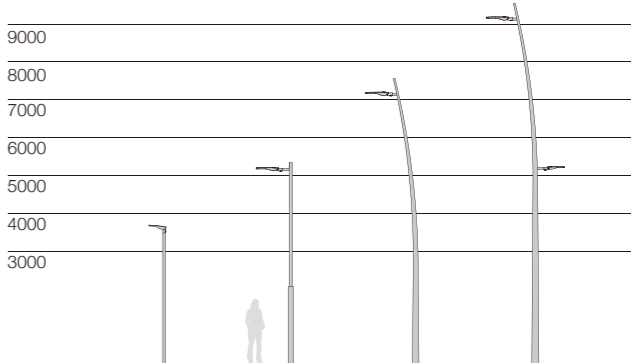

简述 Description



- 铝压铸灯体外壳，超白钢化玻璃
- 高透光PC透镜，具有高视觉舒适性和均匀配光透镜，供多种不同配光选择
- 高性能LED芯片，驱动有0-10V / DALI / 编程电源选择，20KV浪涌保护器
- 灯具采用下翻盖开启方式，设有特殊定制开启螺钉
- 有侧装和顶装2种安装方式，角度可调，安装管径有 $\varnothing 48 / \varnothing 60 / \varnothing 76\text{mm}$
- 防紫外线聚氨酯粉末喷涂表面，盐雾测试可达1000小时以上
- 无生物蓝光危害风险，符合EN62471: 2008标准
- 道路灯智能远程控制系统可选，可以与远程管理系统兼容
- 所有外部螺钉均为304不锈钢材质

- Die-casting aluminium body, super white tempered glass.
- Optics with PC lens with high visual comfortable and uniform lighting distribution, multiple light distribution options.
- High quality LED chips, Driver with 0-10V/DALI/programmed be options, and with surge protection up to 20KV.
- The lighting cover is opened downwards, with special customized opening screw.
- Top and side fixing, angle can be adjustable, installation tube diameter $\varnothing 48/\varnothing 60/\varnothing 76\text{mm}$.
- Surface anti-ultraviolet pure polyester powder painting, Corrosion resistance can be more than 1000 hours.
- No photo-biological risk, (no risk linked to infrared, blue light and UV radiation) in accordance with EN 62471:2008.
- Street lighting control used with smart control technology. It can be compatible with remote management system.
- All external screws are made of 304 stainless steel.



应用透镜 Optics application

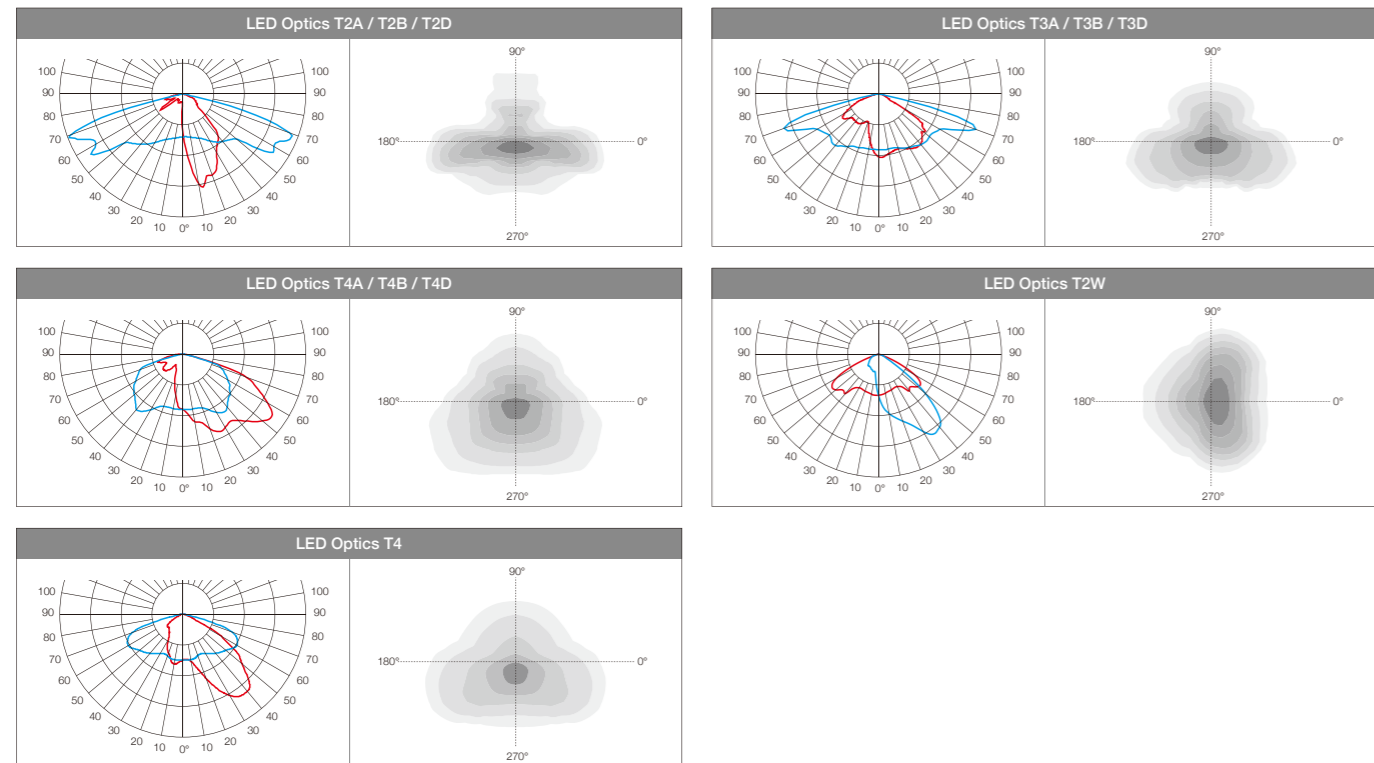

技术参数 Technology data

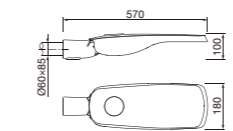
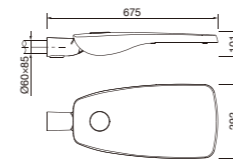

D-180M

Code	Power	LED Qty	Optics	Packing Size	Weight	Pcs/20"	Pcs/40"
LED chips - 3535/5050							
D-180MLED75-32	75W	32	T2A/T3A/T4A/T2W/T4	735*330*150	7.0	825	1695
D-180MLED100-48	100W	48	T2A/T3A/T4A/T2W/T4	735*330*150	7.0	825	1695
D-180MLED120-48	120W	48	T2A/T3A/T4A/T2W/T4	735*330*150	7.0	825	1695
D-180MLED150-72	150W	72	T2D/T3D/T4D	735*330*150	7.0	825	1695

LED chips - 3030

D-180MLED100-112	100W	112	T2B/T3B/T4B	735*330*150	7.0	825	1695
D-180MLED150-168	150W	168	T2B/T3B/T4B	735*330*150	7.0	825	1695

D-180S

Code	Power	LED Qty	Optics	Packing Size	Weight	Pcs/20"	Pcs/40"
LED chips - 3535/5050							
D-180SLED25-8	25W	8	T2A/T3A/T2W	585*195*110	3.8	1785	3740
D-180SLED40-16	40W	16	T2A/T3A/T2W	585*195*110	3.8	1785	3740
D-180SLED60-24	60W	24	T2D/T3D	585*195*110	3.8	1785	3740

LED chips - 3030

D-180SLED25-28	25W	28	T2B/T3B/T4B	585*195*110	3.8	1785	3740
D-180SLED60-56	60W	56	T2B/T3B/T4B	585*195*110	3.8	1785	3740

Normally Version:
D-180S / D-180M



"A" Version:
D-180SA / D-180MA



可选配件 Accessories options

	Code
$\varnothing 76$ 安装座 Fixing Arm	210001086
$\varnothing 60$ 安装座 Fixing Arm	210000255
$\varnothing 60-48$ 转换套 Adapter Arm / Adapter required for install on the pole.	210002547





D-170L
200-350W



D-170M
120-200W



D-170S
75-150W



D-170S2
25-60W



D-170S1
60-100W

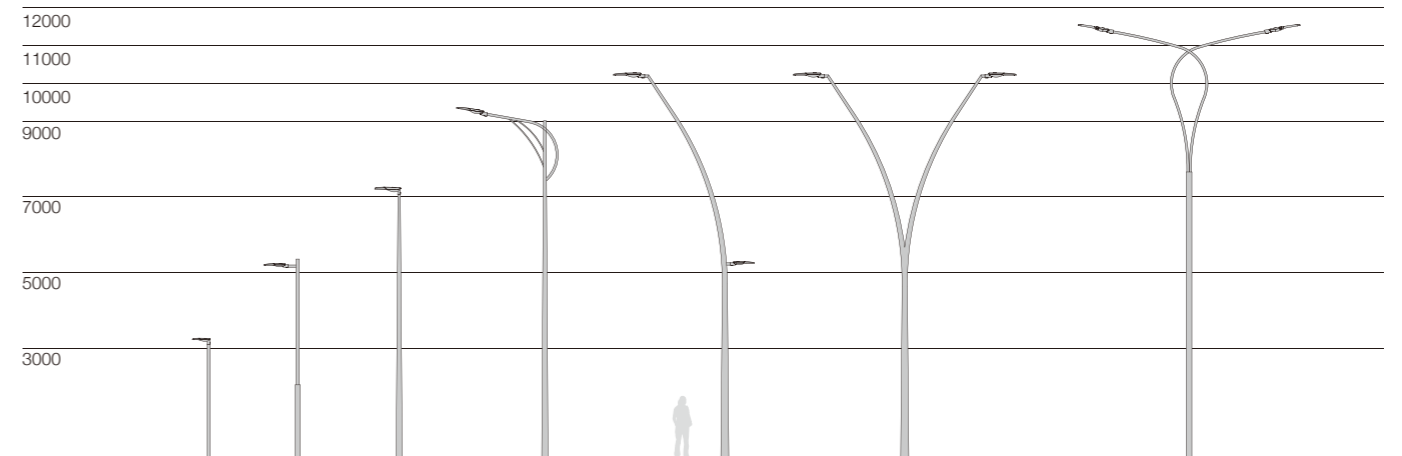



简述 Description



- 铝压铸灯体外壳，超白钢化玻璃
- 高透光PC透镜，具有高视觉舒适性和均匀配光透镜，供多种不同配光选择
- 高性能LED芯片，驱动有0-10V / DALI / 编程电源选择，20KV浪涌保护器
- 按钮式开启配置，内设有开启断电保护器
- 有侧装和顶装2种安装方式，角度可调，安装管径有 $\varnothing 48 / \varnothing 60 / \varnothing 76$ mm
- 防紫外线聚氨酯塑粉喷涂表面，盐雾测试可以达1000小时以上
- 无生物蓝光危害风险，符合EN62471: 2008标准
- 道路灯智能远程控制系统可选，可以与远程管理系统兼容
- 所有外部螺钉均为304不锈钢材质

- Die-casting aluminium body, super white tempered glass.
- Optics with PC lens with high visual comfortable and uniform lighting distribution, multiple light distribution options.
- High quality LED chips, Driver with 0-10V/DALI/programmed be options, and with surge protection up to 20KV.
- Tool-free replaceable with push-button for opened device, automatic on/off connector when be open.
- Top and side fixing, angle can be adjustable, installation tube diameter $\varnothing 48/\varnothing 60/\varnothing 76$ mm.
- Surface anti-ultraviolet pure polyester powder painting, Corrosion resistance can be more than 1000 hours.
- No photo-biological risk, (no risk linked to infrared, blue light and UV radiation) in accordance with EN 62471:2008.
- Street lighting control used with smart control technology. It can be compatible with remote management system.
- All external screws are made of 304 stainless steel.

应用透镜 Optics application

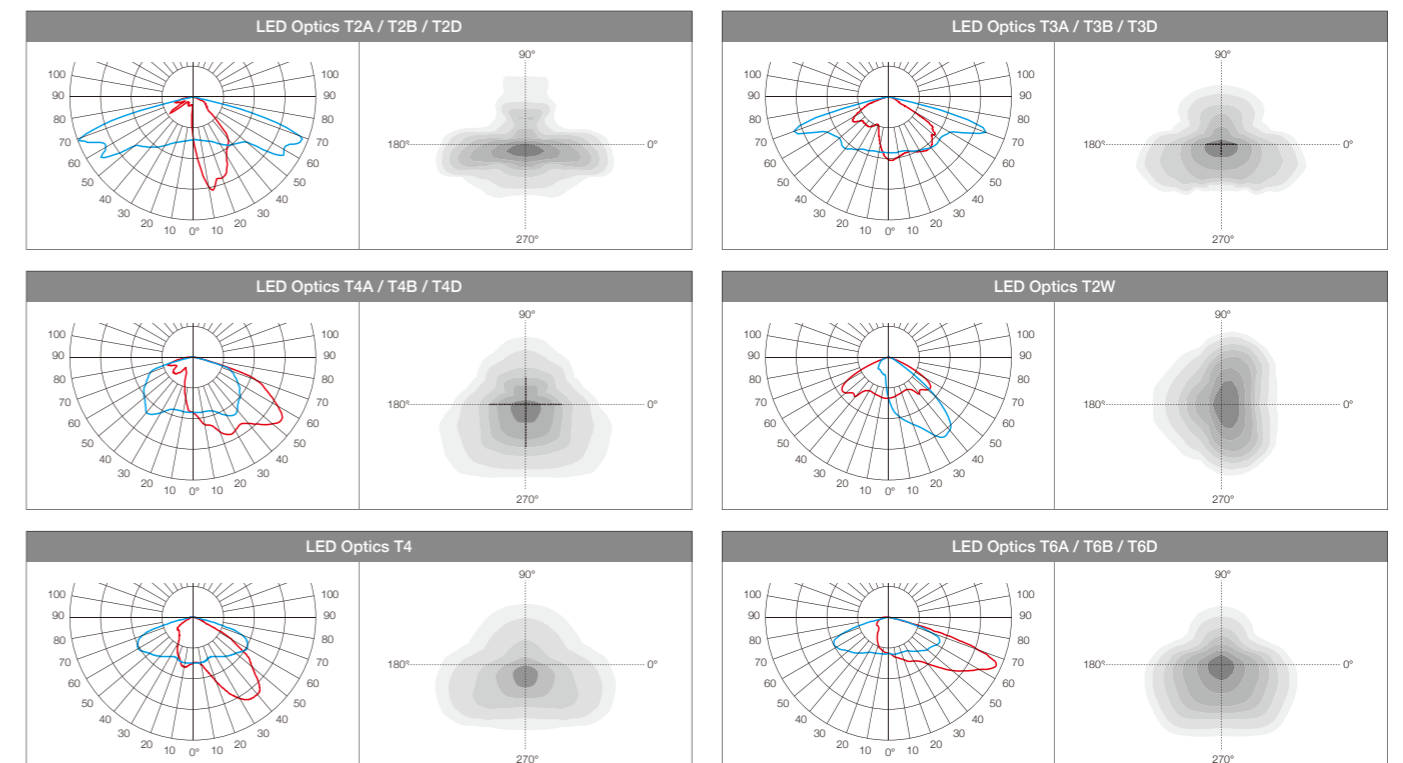



IP66电气腔室，可以接入智能照明控制实现节能
IP66 electrical housing, it can be installed dimming control system to saving energy.



IK09钢化玻璃罩，可适配Zhaga标准PCB板，模组式透镜供多种不同光型可选，以满足不同路面的照明需求
IK09 tempered glass, it is suitable for zhaga standard PCB. Modular lens are available for various light types to meet the lighting requirements of different roads.



灯具免工具打开设计，“L”号灯具采用两边铝压铸扣攀快速打开锁紧系统
Tool-Free design, "L" version with aluminum fastening locker.



灯具免工具打开设计，其他尺寸灯具，背部采用按压式按钮打开系统
Others size version, botton design locker.



灯具具有横装、竖装二种方式，角度可以±15度调节

Top or side fitting Ø60mm, Ø76 arm be option, ±15° angle adjustable.



5
SIZES



D-170 Series

一组实用型高端LED路灯，灯具共有5个尺寸版本，分别功率从25W-350W，可适用于不同道路功能照明需求，多种光学系统可选配。

A practical high-end LED street lighting, there are five sizes to option, with power from 25W to 350W. It can be used for lighting requirements of different road functions. A variety of optical systems can be selected.

技术参数 Technology data



D-170L

Code	Power	LED Qty	Optics	Packing Size	Weight	Pcs/20"	Pcs/40"
LED chips - 3535/5050							
D-170LLED200-96	200W	96	T3A/T4A/T5A/T4	975*470*155	18.4	336	700
D-170LLED240-96	240W	96	T3A/T4A/T5A/T4	975*470*155	18.4	336	700
D-170LLED240-120	240W	120	T3A/T4A/T5A/T4	975*470*155	18.4	336	700
D-170LLED300-120	300W	120	T3A/T4A/T5A/T4	975*470*155	18.4	336	700
D-170LLED350-144	350W	144	T3A/T4A/T5A/T4	975*470*155	18.4	336	700

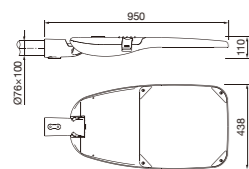

D-170M

Code	Power	LED Qty	Optics	Packing Size	Weight	Pcs/20"	Pcs/40"
LED chips - 3535/5050							
D-170MLED120-48 A3	120W	48	T3A/T4A/T5A/T2W/T4	840*365*150	10.5	560	1176
D-170MLED150-48 A3	150W	48	T3A/T4A/T5A/T2W/T4	840*365*150	10.6	560	1176
D-170MLED150-64 A3	150W	64	T3A/T4A/T5A/T2W/T4	840*365*150	10.6	560	1176
D-170MLED180-64 A3	180W	64	T3A/T4A/T5A/T2W/T4	840*365*150	10.6	560	1176
D-170MLED200-96 D3	200W	96	T3D/T4D/T5D	840*365*150	10.6	560	1176

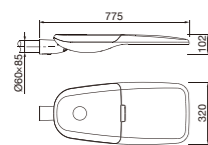

D-170S

Code	Power	LED Qty	Optics	Packing Size	Weight	Pcs/20"	Pcs/40"
LED chips - 3535/5050							
D-170SLED75-32 A3	75W	32	T2A/T3A/T4A/T2W/T4	685*315*150	7.6	840	1722
D-170SLED100-32 A3	100W	32	T2A/T3A/T4A/T2W/T4	685*315*150	7.6	840	1722
D-170SLED120-48 A3	120W	48	T2A/T3A/T4A/T2W/T4	685*315*150	7.6	840	1722
D-170SLED150-48 A3	150W	48	T2A/T3A/T4A/T2W/T4	685*315*150	7.6	840	1722

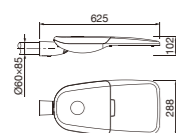

LED chips - 3030							
D-170SLED75-112 B3	75W	112	T2B/T3B/T4B	685*315*150	7.6	840	1722
D-170SLED100-168 B3	100W	168	T2B/T3B/T4B	685*315*150	7.6	840	1722
D-170SLED120-168 B3	120W	168	T2B/T3B/T4B	685*315*150	7.6	840	1722



D-170S1

Code	Power	LED Qty	Optics	Packing Size	Weight	Pcs/20"	Pcs/40"
LED chips - 3535/5050							
D-170S1LED60-24 A1	60W	24	T2A/T3A/T2W/T4	580*280*150	6.2	1200	2310
D-170S1LED75-36 D1	75W	36	T2D/T3D/T4D	580*280*150	6.3	1200	2310
D-170S1LED100-36 D1	100W	36	T2D/T3D/T4D	580*280*150	6.3	1200	2310

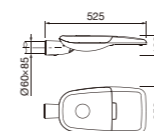

LED chips - 3030							
D-170S1LED60-84 B1	60W	84	T2B/T3B/T4B	580*280*150	6.2	1200	2310
D-170S1LED75-84 B1	75W	84	T2B/T3B/T4B	580*280*150	6.3	1200	2310



D-170S2

Code	Power	LED Qty	Optics	Packing Size	Weight	Pcs/20"	Pcs/40"
LED chips - 3535/5050							
D-170S2LED25-8 A1	25W	8	T2A/T3A/T4A/T2W/T4	535*215*125	5.1	1904	3927
D-170S2LED40-16 A1	40W	16	T2A/T3A/T4A/T2W/T4	535*215*125	5.2	1904	3927
D-170S2LED60-24 D1	60W	24	T2D/T3D/T4D	535*215*125	5.2	1904	3927

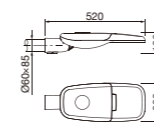

LED chips - 3030							
D-170S2LED25-28 B1	25W	28	T2B/T3B/T4B	535*215*125	5.1	1904	3927
D-170S2LED40-56 B1	40W	56	T2B/T3B/T4B	535*215*125	5.1	1904	3927
D-170S2LED60-56 B1	60W	56	T2B/T3B/T4B	535*215*125	5.2	1904	3927

可选配件 Accessories options

	Code
Ø76安装座 Fixing Arm	210001086
Ø60安装座 Fixing Arm	210000255
Ø60-48转换套 Adapter	210002547

Arm / Adapter required for install on the pole.



T-160L / D-160H

Exclusivity in Spain

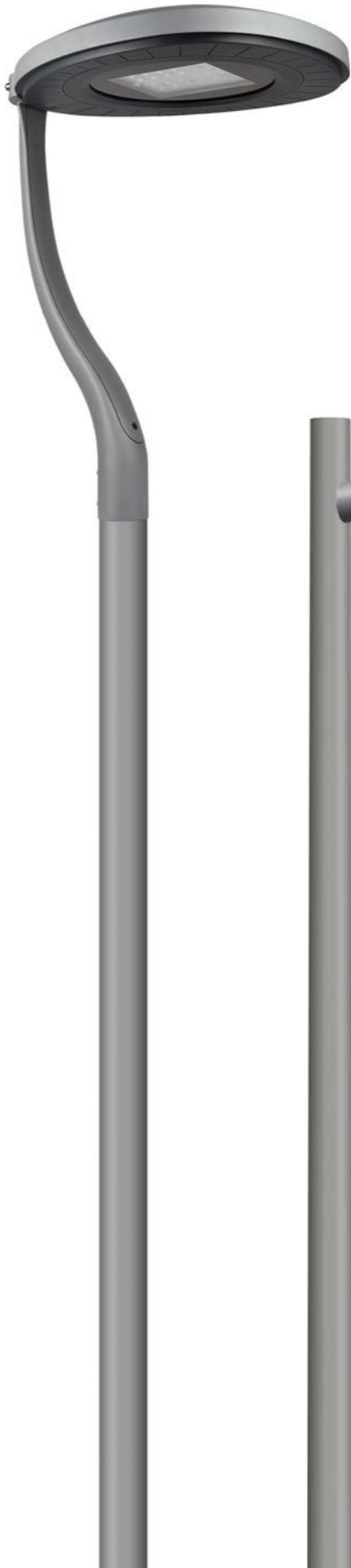

T-160L
40-75W



D-160H
40-100W

一组庭院式路灯，有二种不同安装支架，角度可调，可适用在庭院、小区、步行街等场所，功率范围为40W-100W。

The utility model relates to a courtyard street lighting, which has two different mounting brackets and adjustable angle. It can be used in courtyard, community, pedestrian street and other places. The power range is 40W-100W.

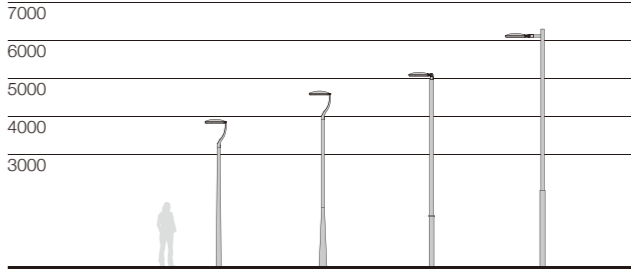

T-160L / D-160H

Exclusivity in Spain



简述 Description



- 铝压铸灯体外壳，超白钢化玻璃
- 高透光PC透镜，具有高视觉舒适性和均匀配光透镜，供多种不同配光选择
- 高性能LED芯片，驱动有0-10V / DALI / 编程电源选择，20KV浪涌保护器
- 有多种安装支架供选择搭配，形成多款不同外形灯具
- 有侧装和顶装2种安装方式，角度可调，安装管径有 $\varnothing 48 / \varnothing 60\text{mm}$
- 防紫外线聚氨酯塑粉喷涂表面，盐雾测试可以达1000小时以上
- 无生物蓝光危害风险，符合EN62471: 2008标准
- 道路灯智能远程控制系統可选，可以与远程管理系统兼容
- 所有外部螺钉均为304不锈钢材质

- Die-casting aluminium body, super white tempered glass.
- Optics with PC lens with high visual comfortable and uniform lighting distribution, multiple light distribution options.
- High quality LED chips, Driver with 0-10V/DALI/programmed be options, and with surge protection up to 20KV.
- There are a variety of mounting brackets options, form of different shapes of lightng.
- Top and side fixing, angle can be adjustable, installation tube diameter $\varnothing 48/\varnothing 60\text{mm}$.
- Surface anti-ultraviolet pure polyester powder painting, Corrosion resistance can be more than 1000 hours.
- No photo-biological risk, (no risk linked to infrared, blue light and UV radiation) in accordance with EN 62471:2008.
- Street lighting control used with smart control technology. It can be compatible with remote management system.
- All external screws are made of 304 stainless steel.



应用透镜 Optics application

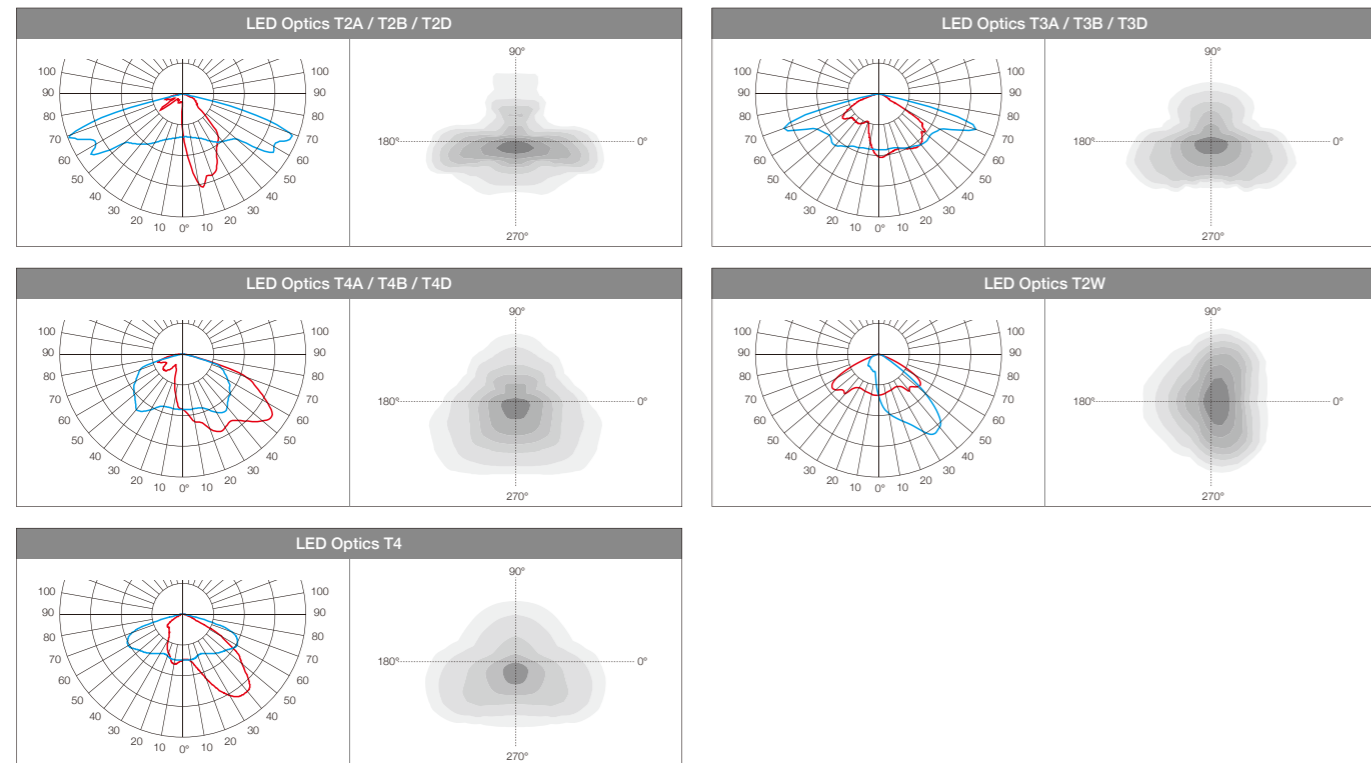

技术参数 Technology data

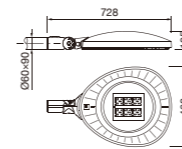
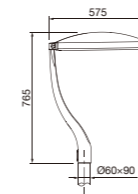

T-160L

Code	Power	LED Qty	Optics	Packing Size	Weight	Pcs/20"	Pcs/40"
LED chips - 3535/5050				Body:			
T-160LLED40-24 A2	40W	24	T1/T2A/T3A/T4A/T2W/T4	570*500*155	10.2	512	1080
T-160LLED60-24 A2	60W	24	T1/T2A/T3A/T4A/T2W/T4	570*500*155	10.2	512	1080
T-160LLED75-36 A2	75W	36	T1/T2A/T3A/T4A/T2W/T4	570*500*155	10.2	512	1080

LED chips - 3030

T-160LLED40-56 B4	40W	56	T1B/T2B/T3B/T4B	570*500*155	10.2	512	1080
T-160LLED60-84 B2	60W	84	T1B/T2B/T3B/T4B	570*500*155	10.2	512	1080
T-160LLED75-84 B2	75W	84	T1B/T2B/T3B/T4B	570*500*155	10.2	512	1080

Bracket:
780*440*235/8pcs

D-160H

Code	Power	LED Qty	Optics	Packing Size	Weight	Pcs/20"	Pcs/40"
LED chips - 3535/5050							
D-160HLED40-24 A2	40W	24	T2A/T3A/T4A/T2W/T4	620*500*155	10.0	560	1176
D-160HLED60-24 A2	60W	24	T2A/T3A/T4A/T2W/T4	620*500*155	10.0	560	1176
D-160HLED75-36 A2	75W	36	T2A/T3A/T4A/T2W/T4	620*500*155	10.2	560	1176
D-160HLED100-36 A2	100W	36	T2A/T3A/T4A/T2W/T4	620*500*155	10.2	560	1176

LED chips - 3030

D-160HLED40-56 B4	40W	56	T2B/T3B/T4B	620*500*155	10.0	560	1176
D-160HLED60-84 B2	60W	84	T2B/T3B/T4B	620*500*155	10.0	560	1176
D-160HLED75-84 B2	75W	84	T2B/T3B/T4B	620*500*155	10.0	560	1176
D-160HLED100-126 B2	100W	126	T2B/T3B/T4B	620*500*155	10.2	560	1176





D-150 Series



D-150MN
120-200W



D-150SA
60-120W



D-150S1
25-60W

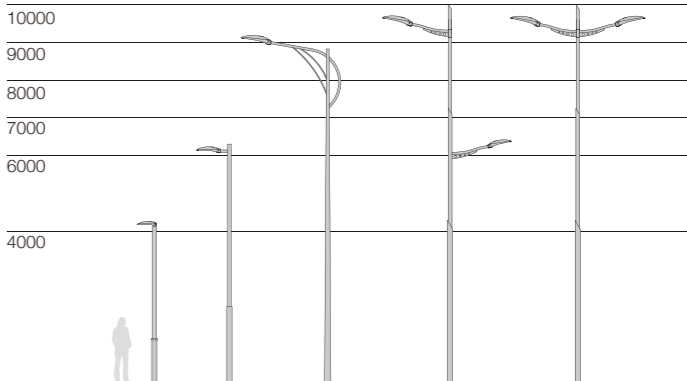



IP66电器腔室，灯具打开时有支撑杆防护和自动断电装置，有效保护灯具安全

IP66 electrical box housing, when the lighting open there is support rod protection and automatic power-off device to effectively protect the safety.



流线型灯具外形设计，具有很好的雨水自洁功能，同时内藏式散热筋结构，能有效保证散热

Streamline shape design, with good rain self-cleaning function, built-in heat sink structure, it can effectively ensure heat dissipation.



灯具免工具打开设计，采用按压式按钮打开装置，模组式透镜供多种不同光型可选，以满足不同路面的照明需求

Tool-Free design, bottom design locker, Modular lens is available for various light types to meet the lighting requirements of different roads.



灯具具有横装、竖装二种方式，角度可以-15~+10度调节

Top or side fitting Ø60mm, Ø76 arm be option, -15° ~ +10° angle adjustable.



3
SIZES



D-150 Series

一组流线型设计的LED路灯，内藏式散热筋结构，能有效保证散热，外壳又能保证自洁功能。灯具功率范围为30W-200W。

A streamlined design of LED street lighting, built-in heat sink structure, can effectively ensure heat dissipation, and the shell can ensure self-cleaning function. The power range is 30W-200W.

简述 Description



- 铝压铸灯体外壳，超白钢化玻璃，镀铬塑料反射罩
- 高透光PC透镜，具有高视觉舒适性和均匀配光透镜，供多种不同配光选择
- 高性能LED芯片，驱动有0-10V / DALI / 编程电源选择，20KV浪涌保护器
- 按钮式开启配置，内设有开启断电保护器
- 内藏式散热筋设计，上盖外表面光滑平整，在保证散热时又有好的雨水自洁功能
- 有侧装和顶装2种安装方式，角度可调，安装管径有 $\varnothing 48 / \varnothing 60 / \varnothing 76$ mm
- 防紫外线聚氨酯塑粉喷涂表面，盐雾测试可达1000小时以上
- 无生物蓝光危害风险，符合EN62471: 2008标准
- 道路灯智能远程控制系统可选，可以与远程管理系统兼容
- 所有外部螺钉均为304不锈钢材质

- Die-casting aluminium body, super white tempered glass, Chrome plastic reflector.
- Optics with PC lens with high visual comfortable and uniform lighting distribution, multiple light distribution options.
- High quality LED chips, Driver with 0-10V/DALI/programmed options, and with surge protection up to 20KV.
- Tool-free replaceable with push-button for opened device, automatic on/off connector when be open.
- Built-in radiating ribs, and smooth surface of the upper cover, which ensures the heat dissipation and has good rainwater self-cleaning function.
- Top and side fixing, angle can be adjustable, installation tube diameter $\varnothing 48/\varnothing 60/\varnothing 76$ mm.
- Surface anti-ultraviolet pure polyester powder painting, Corrosion resistance can be more than 1000 hours.
- No photo-biological risk, (no risk linked to infrared, blue light and UV radiation) in accordance with EN 62471:2008.
- Street lighting control used with smart control technology. It can be compatible with remote management system.
- All external screws are made of 304 stainless steel.

应用透镜 Optics application

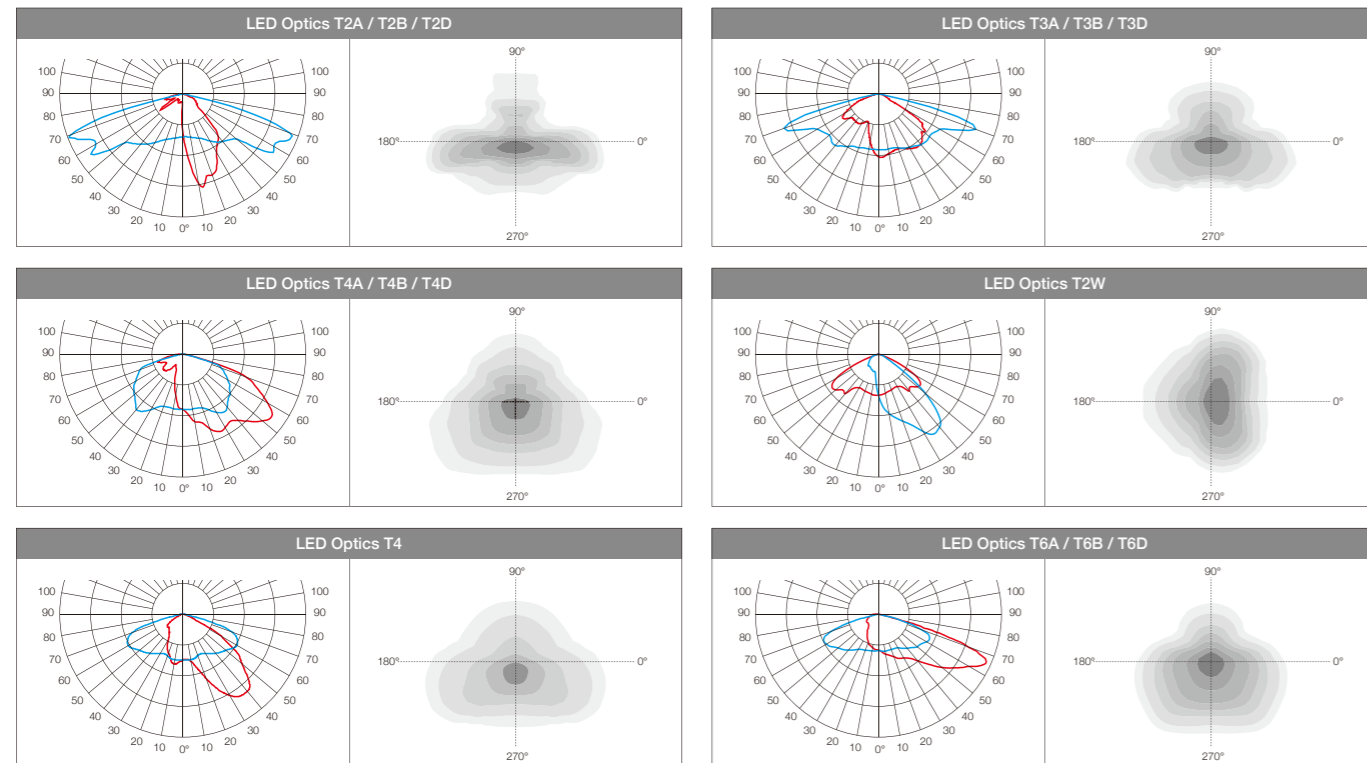

技术参数 Technology data

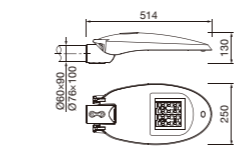
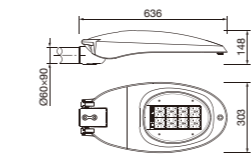
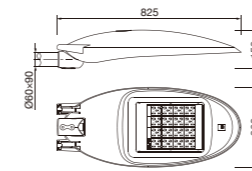

D-150MN

Code	Power	LED Qty	Optics	Packing Size	Weight	Pcs/20"	Pcs/40"
LED chips - 3535/5050							
D-150MNLED120-48	120W	48	T3A/T4A/T5A/T2W/T4	875*400*210	13.3	340	710
D-150MNLED150-64	150W	64	T3A/T4A/T5A/T2W/T4	875*400*210	13.3	340	710
D-150MNLED180-64	180W	64	T3A/T4A/T5A/T2W/T4	875*400*210	13.3	340	710
D-150MNLED200-96	200W	96	T3D/T4D	875*400*210	13.3	340	710

D-150SA

Code	Power	LED Qty	Optics	Packing Size	Weight	Pcs/20"	Pcs/40"
LED chips - 3535/5050							
D-150SALED60-24	60W	24	T2D/T3D/T4D	690*335*190	8.3	612	1260
D-150SALED75-32	75W	32	T2A/T3A/T4A/T2W/T4	690*335*190	8.3	612	1260
D-150SALED100-48	100W	48	T2D/T3D/T4D	690*335*190	8.3	612	1260
D-150SALED120-48	120W	48	T2D/T3D/T4D	690*335*190	8.3	612	1260

LED chips - 3030

D-150SALED75-112	75W	112	T2B/T3B/T4B	690*335*190	8.3	612	1260
D-150SALED100-112	100W	112	T2B/T3B/T4B	690*335*190	8.3	612	1260

D-150S1

Code	Power	LED Qty	Optics	Packing Size	Weight	Pcs/20"	Pcs/40"
LED chips - 3535/5050							
D-150S1LED25-16	25W	16	T2A/T3A/T4A/T2W/T4	575*265*170	5.3	1092	2288
D-150S1LED40-16	40W	16	T2A/T3A/T4A/T2W/T4	575*265*170	5.3	1092	2288
D-150S1LED60-24	60W	24	T2D/T3D/T4D	575*265*170	5.3	1092	2288

LED chips - 3030

D-150S1LED40-56	40W	56	T2B/T3B/T4B	575*265*170	5.3	1092	2288
D-150S1LED60-56	60W	56	T2B/T3B/T4B	575*265*170	5.3	1092	2288

可选配件 Accessories options

	Code
$\varnothing 76$ 安装座 Fixing Arm	210000960
$\varnothing 60$ 安装座 Fixing Arm	210000211
$\varnothing 60-48$ 转换套 Adapter Arm / Adapter required for install on the pole.	210002547



D-120 Series



D-120MN
100-180W



D-120SN
60-100W



D-120S1N
25-60W

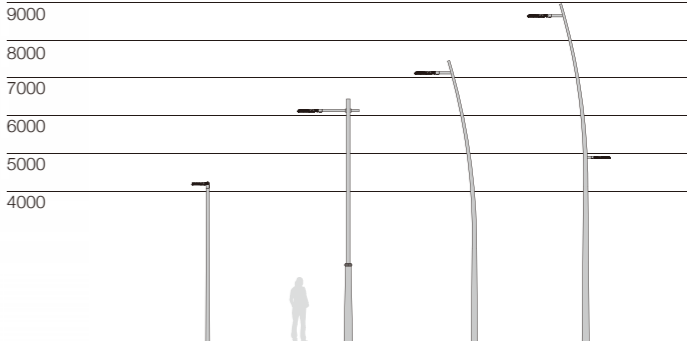

简述 Description



- 铝压铸灯体外壳，超白钢化玻璃，镀铬塑料反射罩
- 高透光PC透镜，具有高视觉舒适性和均匀配光透镜，供多种不同配光选择
- 高性能LED芯片，驱动有0-10V / DALI / 编程电源选择，20KV浪涌保护器
- 独立维修门设计，安装维修方便
- 有侧装和顶装2种安装方式，角度可调，安装管径有Ø48 / Ø60 / Ø76mm
- 防紫外线聚氨酯粉末喷涂表面，盐雾测试可达1000小时以上
- 无生物蓝光危害风险，符合EN62471: 2008标准
- 道路灯智能远程控制系统可选，可以与远程管理系统兼容
- 所有外部螺钉均为304不锈钢材质

- Die-casting aluminium body, super white tempered glass, Chrome plastic reflector.
- Optics with PC lens with high visual comfortable and uniform lighting distribution, multiple light distribution options.
- High quality LED chips, Driver with 0-10V/DALI/programmed be options, and with surge protection up to 20KV.
- Independent maintenance door design, easy installation and maintenance.
- Top and side fixing, angle can be adjustable, installation tube diameter Ø48/Ø60/Ø76mm.
- Surface anti-ultraviolet pure polyester powder painting, Corrosion resistance can be more than 1000 hours.
- No photo-biological risk, (no risk linked to infrared, blue light and UV radiation) in accordance with EN 62471:2008.
- Street lighting control used with smart control technology. It can be compatible with remote management system.
- All external screws are made of 304 stainless steel.



应用透镜 Optics application

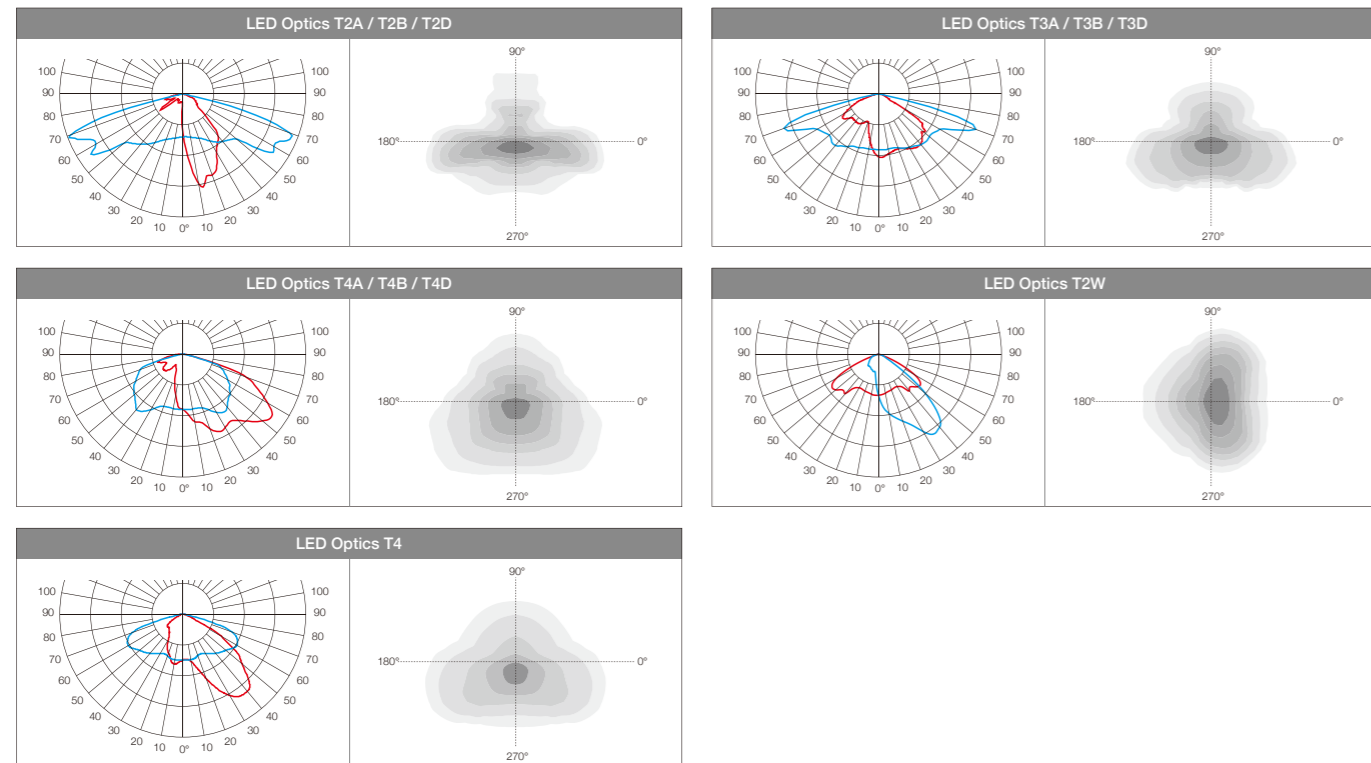

技术参数 Technology data



D-120MN

Code	Power	LED Qty	Optics	Packing Size	Weight	Pcs/20"	Pcs/40"
LED chips - 3535/5050							
D-120MNLED100-48	100W	48	T3A/T4A/T5A/T2W/T4	835*335*155	12.0	602	1274
D-120MNLED120-48	120W	48	T3A/T4A/T5A/T2W/T4	835*335*155	12.2	602	1274
D-120MNLED150-60	150W	60	T3A/T4A/T5A/T2W/T4	835*335*155	12.2	602	1274
D-120MNLED180-60	180W	60	T3A/T4A/T5A/T2W/T4	835*335*155	12.5	602	1274

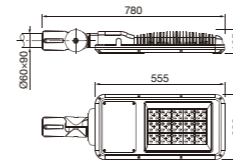

D-120SN

Code	Power	LED Qty	Optics	Packing Size	Weight	Pcs/20"	Pcs/40"
LED chips - 3535/5050							
D-120SNLED60-24	60W	24	T2A/T3A/T4A/T2W/T4	685*300*135	7.3	882	1806
D-120SNLED75-32	75W	32	T2A/T3A/T4A/T2W/T4	685*300*135	7.4	882	1806
D-120SNLED100-48	100W	48	T2D/T3D/T4D	685*300*135	7.4	882	1806

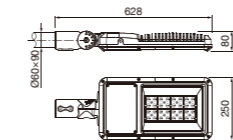

LED chips - 3030

D-120SNLED75-112	75W	112	T2B/T3B/T4B	685*300*135	7.4	882	1806
D-150SNLED100-112	100W	112	T2B/T3B/T4B	685*300*135	7.4	882	1806



D-120S1N

Code	Power	LED Qty	Optics	Packing Size	Weight	Pcs/20"	Pcs/40"
LED chips - 3535/5050							
D-120S1NLED25-12	25W	12	T2A/T3A/T4A/T2W/T4	545*235*95	4.9	2200	4576
D-120S1NLED40-24	40W	24	T2A/T3A/T4A/T2W/T4	545*235*95	5.0	2200	4576
D-120S1NLED60-24	60W	24	T2A/T3A/T4A/T2W/T4	545*235*95	5.0	2200	4576

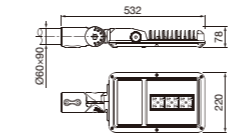

LED chips - 3030

D-120S1NLED40-56	40W	56	T2B/T3B/T4B	545*235*95	5.0	2200	4576
D-120S1NLED60-84	60W	84	T2B/T3B/T4B	545*235*95	5.0	2200	4576

延伸产品 More in family



S-120MN / S-120SN TG-120S1 / TG-120S1N

Tunnel Lighting: 60~180W.

Flood Lighting: 25~75W.

可选配件 Accessories options

			Code
	Ø76安装座	Fixing Arm Only for D-120MN	210001812
	Ø60安装座	Fixing Arm Only for D-120MN	210000274
	Ø60安装座	Fixing Arm Except for D-120MN	210000196
	Ø60-48转换套	Adapter Arm / Adapter required for install on the pole.	210002547





D-34
40-100W



T-32L
40-100W



D-32
40-100W



D-32S
40-100W

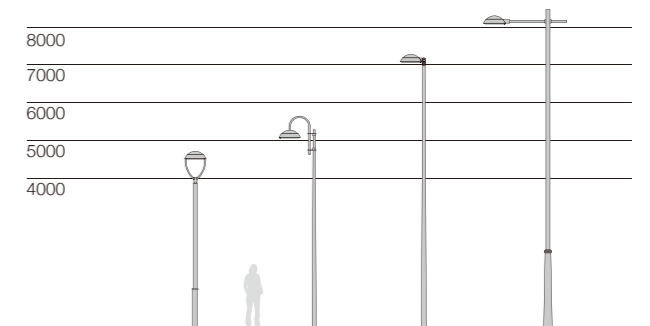



简述 Description



- 铝压铸灯体外壳，超白钢化玻璃，镀铬塑料反射罩
- 高透光PC透镜，具有高视觉舒适性和均匀配光透镜，供多种不同配光选择
- 高性能LED芯片，驱动有0-10V / DALI / 编程电源选择，20KV浪涌保护器
- 按钮式开启装置，配有多种安装支架及不同安装方式
- 灯具采用LED模组，安装更换方便
- 有侧装和顶装和吊装3种安装方式，角度可调，安装管径有 $\varnothing 60 / \varnothing 76\text{mm}$
- 防紫外线聚氨酯粉喷涂表面，盐雾测试可以达1000小时以上
- 无生物蓝光危害风险，符合EN62471: 2008标准
- 道路灯智能远程控制系统可选，可以与远程管理系统兼容
- 所有外部螺钉均为304不锈钢材质



MD-02N LED Module

- Die-casting aluminium body, super white tempered glass, Chrome plastic reflector.
- Optics with PC lens with high visual comfortable and uniform lighting distribution, multiple light distribution options.
- High quality LED chips, Driver with 0-10V/DALI/programmed options, and with surge protection up to 20KV.
- Button type opening device, equipped with a variety of mounting brackets and different installation methods.
- LED module is used inside, which is easy to install and replace.
- Top and side fixing and hanging 3 installations, angle can be adjustable, installation tube diameter $\varnothing 60/\varnothing 76\text{mm}$.
- Surface anti-ultraviolet pure polyester powder painting, Corrosion resistance can be more than 1000 hours.
- No photo-biological risk, (no risk linked to infrared, blue light and UV radiation) in accordance with EN 62471:2008.
- Street lighting control used with smart control technology. It can be compatible with remote management system.
- All external screws are made of 304 stainless steel.

应用透镜 Optics application

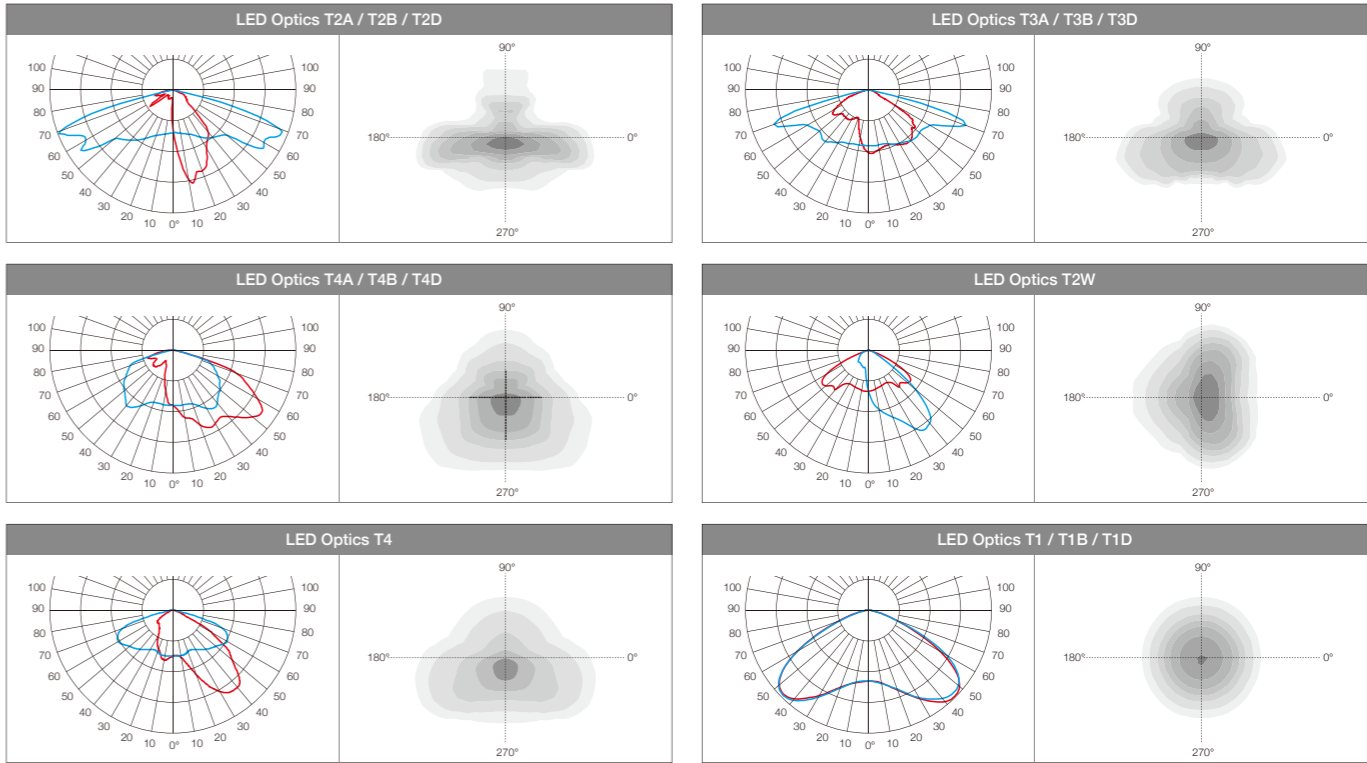

技术参数 Technology data



D-34

Code	Power	LED Qty	Optics	Packing Size	Weight	Pcs/20"	Pcs/40"
LED chips - 3535/5050							
D-34LED40-16 A3	40W	16	T2A/T3A/T4A/T2W/T4	575*575*245	13.9	360	756
D-34LED60-24 D3	60W	24	T2D/T3D/T4D	575*575*245	14.0	360	756
D-34LED75-32 A3	75W	32	T2A/T3A/T4A/T2W/T4	575*575*245	14.3	360	756
D-34LED100-48 D3	100W	48	T2D/T3D/T4D	575*575*245	14.3	360	756

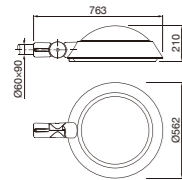

T-32L

Code	Power	LED Qty	Optics	Packing Size	Weight	Pcs/20"	Pcs/40"
LED chips - 3535/5050							
T-32LLED40-16 A3	40W	16	T2A/T3A/T4A/T2W/T4	575*575*245	16.0	300	600
T-32LLED60-24 D3	60W	24	T2D/T3D/T4D	575*575*245	16.0	300	600
T-32LLED75-32 A3	75W	32	T2A/T3A/T4A/T2W/T4	575*575*245	16.6	300	600
T-32LLED100-48 D3	100W	48	T2D/T3D/T4D	575*575*245	16.6	300	600

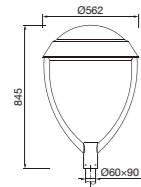

D-32

Code	Power	LED Qty	Optics	Packing Size	Weight	Pcs/20"	Pcs/40"
LED chips - 3535/5050							
D-32LED40-16 A3	40W	16	T2A/T3A/T4A/T2W/T4	575*575*245	12.5	360	756
D-32LED60-24 D3	60W	24	T2D/T3D/T4D	575*575*245	12.5	360	756
D-32LED75-32 A3	75W	32	T2A/T3A/T4A/T2W/T4	575*575*245	12.7	360	756
D-32LED100-48 D3	100W	48	T2D/T3D/T4D	575*575*245	12.7	360	756

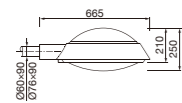

D-32S

Code	Power	LED Qty	Optics	Packing Size	Weight	Pcs/20"	Pcs/40"
LED chips - 3535/5050							
D-32SLED40-16 A3	40W	16	T2A/T3A/T4A/T2W/T4	575*575*245	11.5	360	756
D-32SLED60-24 D3	60W	24	T2D/T3D/T4D	575*575*245	11.5	360	756
D-32SLED75-32 A3	75W	32	T2A/T3A/T4A/T2W/T4	575*575*245	11.7	360	756
D-32SLED100-48 D3	100W	48	T2D/T3D/T4D	575*575*245	11.7	360	756

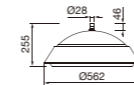

可选配件 Accessories options

		Code
	Ø76安装座 Fixing Arm	210001812
	Ø60安装座 Fixing Arm	210000274
	Ø76-60转换套 Adapter	210001154
	吊装接头 Lifting Joint	250000101
Arm / Adapter required for install on the pole.		







D-21H / T-21L



T-21L
40-100W



D-21H
40-100W

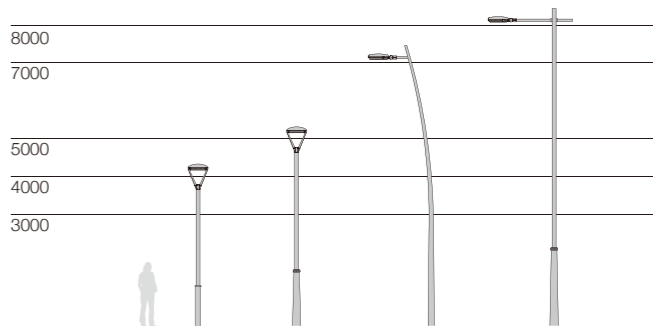

简述 Description



- 铝压铸灯体外壳，超白钢化玻璃，镀铬塑料反射罩
- 高透光PC透镜，具有高视觉舒适性和均匀配光透镜，供多种不同配光选择
- 高性能LED芯片，驱动有0-10V / DALI / 编程电源选择，20KV浪涌保护器
- 铝合金扣攀开启装置，配有多种安装支架及不同安装方式
- 灯具采用LED模组，安装更换方便
- 有侧装和顶装2种安装方式，角度可调，安装管径有 $\varnothing 60 / \varnothing 76\text{mm}$
- 防紫外线聚氨酯塑料喷涂表面，盐雾测试可以达到1000小时以上
- 无生物蓝光危害风险，符合EN62471: 2008标准
- 道路灯智能远程控制选系统可选，可以与远程管理系统兼容
- 所有外部螺钉均为304不锈钢材质



MD-02N LED Module

- Die-casting aluminium body, super white tempered glass, Chrome plastic reflector.
- Optics with PC lens with high visual comfortableable and uniform lighting distribution, multiple light distribution options.
- High quality LED chips, Driver with 0-10V/DALI/programmed options, and with surge protection up to 20KV.
- Tool-free replaceable, die-casting fasten for opened device, equipped with a variety of mounting brackets and different installation methods.
- LED module is used inside, which is easy to install and replace.
- Top and side fixing installation, angle can be adjustable, installation tube diameter $\varnothing 60/\varnothing 76\text{mm}$.
- Surface anti-ultraviolet pure polyester powder painting, Corrosion resistance can be more than 1000 hours.
- No photo-biological risk, (no risk linked to infrared, blue light and UV radiation) in accordance with EN 62471:2008.
- Street lighting control used with smart control technology. It can be compatible with remote management system.
- All external screws are made of 304 stainless steel.

应用透镜 Optics application

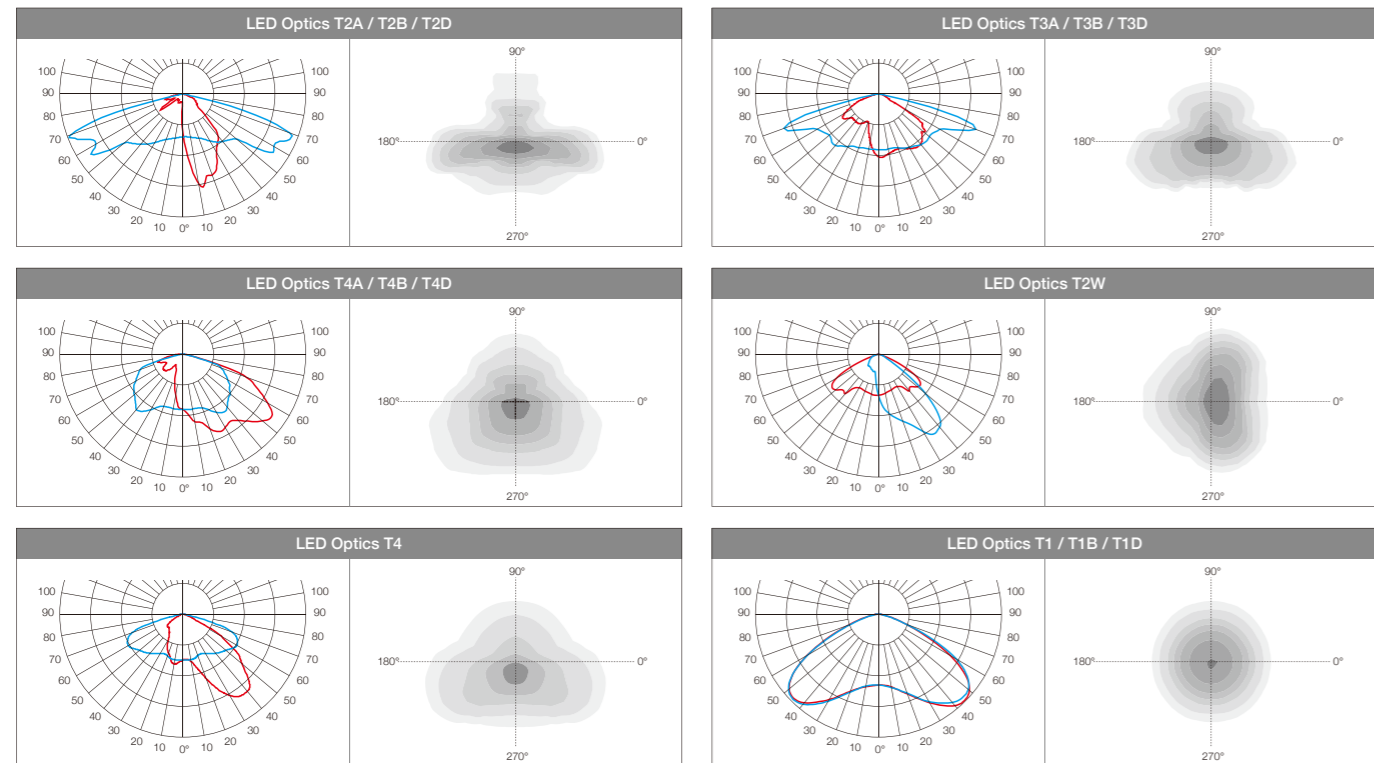

技术参数 Technology data

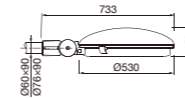

D-21H

Code	Power	LED Qty	Optics	Packing Size	Weight	Pcs/20"	Pcs/40"
LED chips - 3535/5050							
D-21HLED40-16 A3	40W	16	T2A/T3A/T4A/T2W/T4	550*550*220	11.8	400	840
D-21HLED60-24 D3	60W	24	T2D/T3D/T4D	550*550*220	11.8	400	840
D-21HLED75-32 A3	75W	32	T2A/T3A/T4A/T2W/T4	550*550*220	12.0	400	840
D-21HLED100-48 D3	100W	48	T2D/T3D/T4D	550*550*220	12.0	400	840

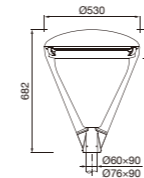

T-21L

Code	Power	LED Qty	Optics	Packing Size	Weight	Pcs/20"	Pcs/40"
LED chips - 3535/5050							
T-21LLED40-16 A3	40W	16	T2A/T3A/T4A/T2W/T4	550*550*195	13.3	328	680
T-21LLED60-24 D3	60W	24	T2D/T3D/T4D	550*550*195	13.3	328	680
T-21LLED75-32 A3	75W	32	T2A/T3A/T4A/T2W/T4	550*550*195	13.5	328	680
T-21LLED100-48 D3	100W	48	T2D/T3D/T4D	550*550*195	13.5	328	680

Bracket:
605*545*250/5pcs

可选配件 Accessories options

	Code
076安装座 Fixing Arm	210001812
060安装座 Fixing Arm	210000274
076安装座 Fixing Arm	210000954
060安装座 Fixing Arm	210000407

Arm / Adapter required for install on the pole.



D-20H / T-20L



T-20L
40-100W



D-20H
40-100W

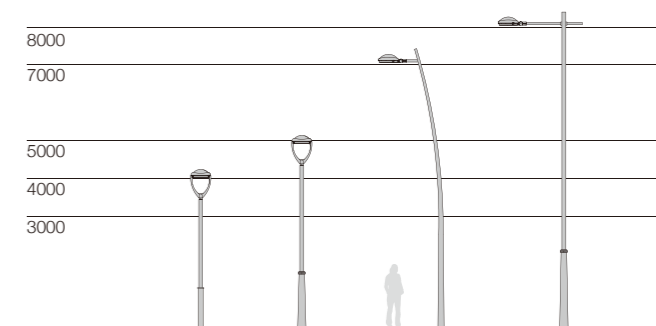

简述 Description



- 铝压铸灯体外壳，超白钢化玻璃，镀铬塑料反射罩
- 高透光PC透镜，具有高视觉舒适性和均匀配光透镜，供多种不同配光选择
- 高性能LED芯片，驱动有0-10V / DALI / 编程电源选择，20KV浪涌保护器
- 铝合金扣攀开启装置，配有多种安装支架及不同安装方式
- 灯具采用LED模组，安装更换方便
- 有侧装和顶装2种安装方式，角度可调，安装管径有 $\varnothing 60 / \varnothing 76\text{mm}$
- 防紫外线聚氨酯塑料喷涂表面，盐雾测试可以达到1000小时以上
- 无生物蓝光危害风险，符合EN62471: 2008标准
- 道路灯智能远程控制系统可选，可以与远程管理系统兼容
- 所有外部螺钉均为304不锈钢材质



MD-02N LED Module

- Die-casting aluminium body, super white tempered glass, Chrome plastic reflector.
- Optics with PC lens with high visual comfortable and uniform lighting distribution, multiple light distribution options.
- High quality LED chips, Driver with 0-10V/DALI/programmed options, and with surge protection up to 20KV.
- Tool-free replaceable, die-casting fasten for opened device, equipped with a variety of mounting brackets and different installation methods.
- LED module is used inside, which is easy to install and replace.
- Top and side fixing installation, angle can be adjustable, installation tube diameter $\varnothing 60/\varnothing 76\text{mm}$.
- Surface anti-ultraviolet pure polyester powder painting, Corrosion resistance can be more than 1000 hours.
- No photo-biological risk, (no risk linked to infrared, blue light and UV radiation) in accordance with EN 62471:2008.
- Street lighting control used with smart control technology. It can be compatible with remote management system.
- All external screws are made of 304 stainless steel.

应用透镜 Optics application

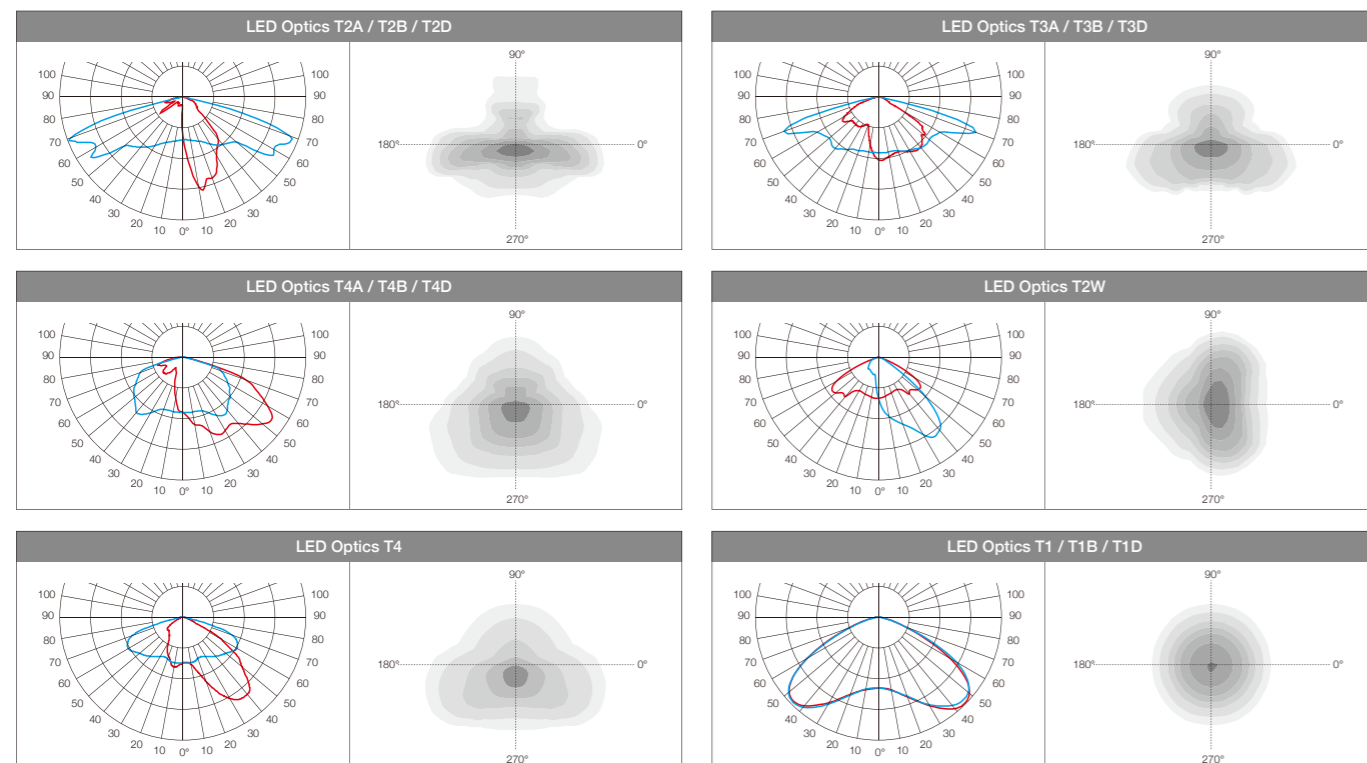

技术参数 Technology data

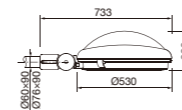

D-20H

Code	Power	LED Qty	Optics	Packing Size	Weight	Pcs/20"	Pcs/40"
LED chips - 3535/5050							
D-20HLED40-16 A3	40W	16	T2A/T3A/T4A/T2W/T4	555*555*255	12.8	360	756
D-20HLED60-24 D3	60W	24	T2D/T3D/T4D	555*555*255	12.8	360	756
D-20HLED75-32 A3	75W	32	T2A/T3A/T4A/T2W/T4	555*555*255	13.0	360	756
D-20HLED100-48 D3	100W	48	T2D/T3D/T4D	555*555*255	13.0	360	756

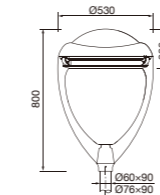

T-20L

Code	Power	LED Qty	Optics	Packing Size	Weight	Pcs/20"	Pcs/40"
LED chips - 3535/5050							
T-20LLED40-16 A3	40W	16	T2A/T3A/T4A/T2W/T4	550*550*250	14.3	288	600
T-20LLED60-24 D3	60W	24	T2D/T3D/T4D	550*550*250	14.3	288	600
T-20LLED75-32 A3	75W	32	T2A/T3A/T4A/T2W/T4	550*550*250	14.5	288	600
T-20LLED100-48 D3	100W	48	T2D/T3D/T4D	550*550*250	14.5	288	600
Bracket: 660*555*265/5pcs							

可选配件 Accessories options

	Code
$\varnothing 76$ 安装座 Fixing Arm	210001812
$\varnothing 60$ 安装座 Fixing Arm	210000274
Arm / Adapter required for install on the pole.	





T-151

KLED

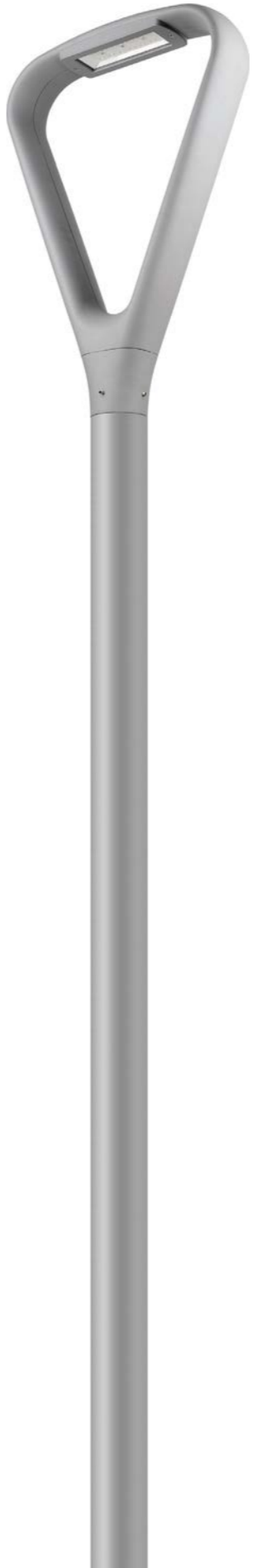

T-151
30-60W



一款极具现代感设计的异形LED庭院灯具，
流线的外形，独特的设计构思，彰显设计者
的独具匠心，灯具功率30W-60W。

A modern design of special-shaped led courtyard
lamps, streamline shape, unique design concept,
highlight the designer's ingenuity, lamp power
30W-60W.

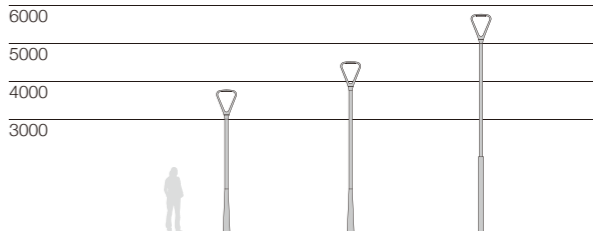

简述 Description



- 铝压铸灯体外壳，超白钢化玻璃，白色PC反射罩
- 高透光PC透镜，具有高视觉舒适性和均匀配光透镜，供多种不同配光选择
- 高性能LED芯片，驱动有0-10V / DALI / 编程电源选择，20KV浪涌保护器
- 灯具采用LED模组，模块式电器部件，安装更换方便
- 防紫外线聚氨酯粉末喷涂表面，盐雾测试可以达1000小时以上
- 无生物蓝光危害风险，符合EN62471: 2008标准
- 道路灯智能远程控制系统可选，可以与远程管理系统兼容
- 所有外部螺钉均为304不锈钢材质



MD-04 LED Module

- Die-casting aluminium body, super white tempered glass, PC white plastic reflector.
- Optics with PC lens with high visual comfortable and uniform lighting distribution, multiple light distribution options.
- High quality LED chips, Driver with 0-10V/DALI/programmed options, and with surge protection up to 20KV.
- LED module is used inside, Integrated electrical components which is easy to install and replace.
- Surface anti-ultraviolet pure polyester powder painting, Corrosion resistance can be more than 1000 hours.
- No photo-biological risk, (no risk linked to infrared, blue light and UV radiation) in accordance with EN 62471:2008.
- Street lighting control used with smart control technology. It can be compatible with remote management system.
- All external screws are made of 304 stainless steel.

应用透镜 Optics application

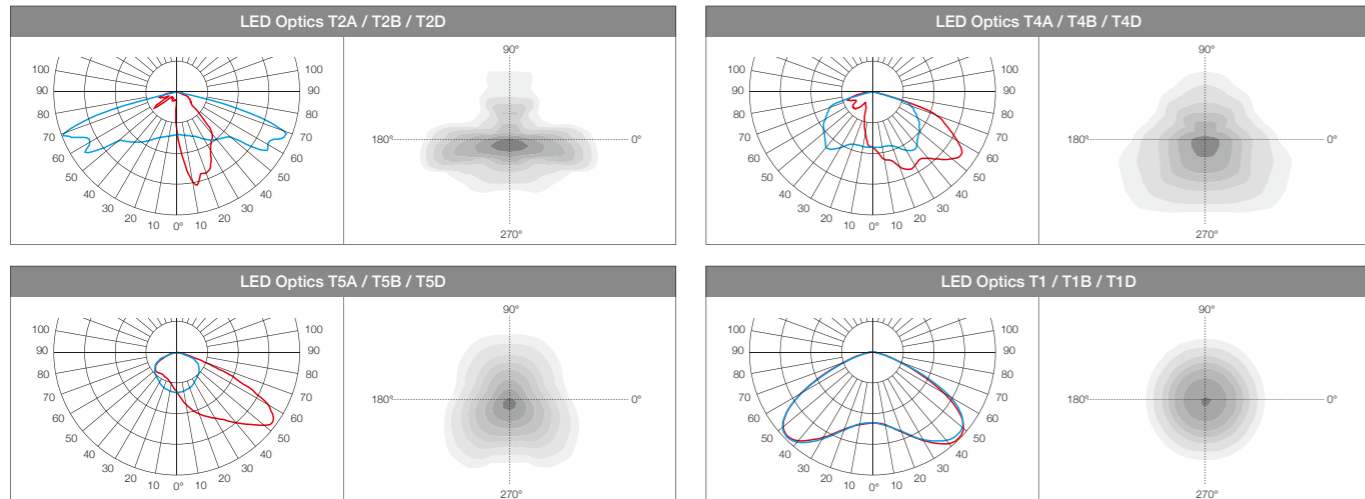

技术参数 Technology data



T-151

Code	Power	LED Qty	Optics	Packing Size	Weight	Pcs/20"	Pcs/40"
LED chips - 3535/5050							
T-151LED30-12	30W	12	T2A/T3A/T4A/T2W/T4	810*520*145	8.5	435	885
T-151LED40-18	40W	18	T1D/T3D/T4D	810*520*145	8.5	435	885
T-151LED60-18	60W	18	T1D/T3D/T4D	810*520*145	8.5	435	885

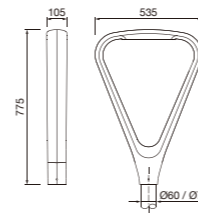

独立防水电器部件
Independent waterproof electrical components.

可选配件 Accessories options

	Code
防水连接器 IP68 Connector	32000047
Ø76-60转换套 Adapter Arm / Adapter required for install on the pole.	210001154





T-92 Series



T-92MP
120-180W

T-92SP
60-100W

T-92MF
120-180W

T-92SF
60-100W



一款古典设计的皇冠灯具，配以独特设计的古典灯杆，能很好的融合到建筑应用场景中，灯具功率由60W-180W，配以合适的透镜应用，达到更好的场景应用照明要求。

A classic crown luminaire which equipped with a unique classic pole, it can be well integrated into the architectural application scene. The product power is 60W-180W, equipped with appropriate lens application, it can meet the better lighting requirements of scene application.

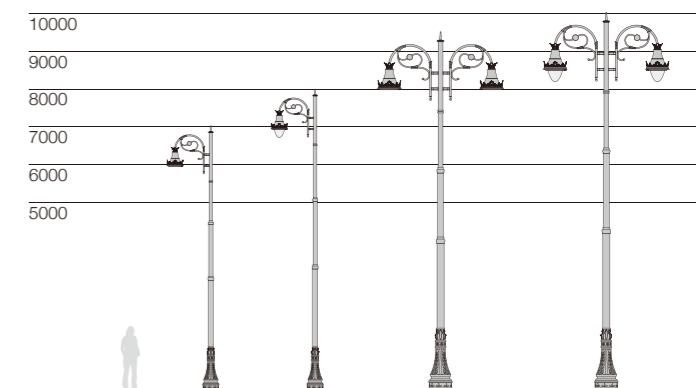

T-92 Series

简述 Description



- 铝压铸灯体外壳，透明PC塑料扩散罩和平面钢化玻璃可以任选
- 高透光PC透镜，具有高视觉舒适性和均匀配光透镜，供多种不同配光选择
- 高性能LED芯片，驱动有0-10V / DALI / 编程电源选择，20KV浪涌保护器
- 古典式外形设计，配有两种安装式样
- 灯具采用LED模组，安装更换方便
- 防紫外线聚氨酯粉喷涂表面，盐雾测试可以达1000小时以上
- 无生物蓝光危害风险，符合EN62471: 2008标准
- 道路灯智能远程控制系统可选，可以与远程管理系统兼容
- 所有外部螺钉均为304不锈钢材质

- Die-casting aluminium body, transparent PC plastic diffusion cover or flat tempered glass.
- Optics with PC lens with high visual comfortable and uniform lighting distribution, multiple light distribution options.
- High quality LED chips, Driver with 0-10V/DALI/programmed options, and with surge protection up to 20KV.
- Classical shape design, with two installation type.
- LED module is used inside, which is easy to install and replace.
- Surface anti-ultraviolet pure polyester powder painting, Corrosion resistance can be more than 1000 hours.
- No photo-biological risk, (no risk linked to infrared, blue light and UV radiation) in accordance with EN 62471:2008.
- Street lighting control used with smart control technology. It can be compatible with remote management system.
- All external screws are made of 304 stainless steel.

应用透镜 Optics application

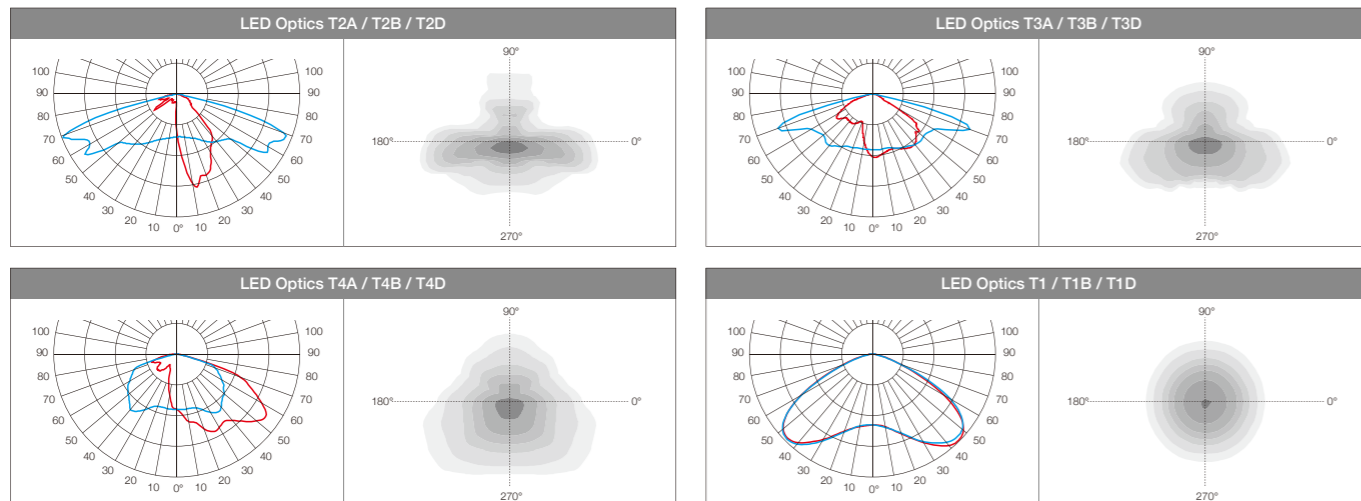

技术参数 Technology data



T-92MP

Code	Power	LED Qty	Optics	Packing Size	Weight	Pcs/20"	Pcs/40"
LED chips - 3535/5050							
T-92MPLED120-48 A3	120W	48	T1/T2A/T3A/T4A/T2W/T4	590*590*560	13.8	108	240
T-92MPLED150-48 A3	150W	48	T1/T2A/T3A/T4A/T2W/T4	590*590*560	13.8	108	240
T-92MPLED180-72 D3	180W	72	T1D/T2D/T3D/T4D	590*590*560	14.0	108	240

PC Cover:
415*415*640/5pcs

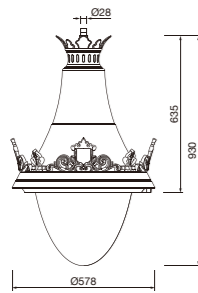

T-92SP

Code	Power	LED Qty	Optics	Packing Size	Weight	Pcs/20"	Pcs/40"
LED chips - 3535/5050							
T-92SPLED60-36 A2	60W	36	T1/T2A/T3A/T4A	500*500*480	11.2	165	350
T-92SPLED75-36 A2	75W	36	T1/T2A/T3A/T4A	500*500*480	11.2	165	350
T-92SPLED100-36 A2	100W	36	T1/T2A/T3A/T4A	500*500*480	11.5	165	350

PC Cover:
345*345*425/5pcs

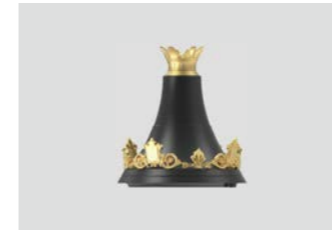
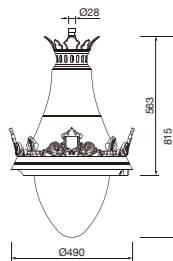

T-92MF

Code	Power	LED Qty	Optics	Packing Size	Weight	Pcs/20"	Pcs/40"
LED chips - 3535/5050							
T-92MFLED120-48 A3	120W	48	T1/T2A/T3A/T4A/T2W/T4	590*590*560	13.8	108	240
T-92MFLED150-48 A3	150W	48	T1/T2A/T3A/T4A/T2W/T4	590*590*560	13.8	108	240
T-92MFLED180-72 D3	180W	72	T1D/T2D/T3D/T4D	590*590*560	14.0	108	240

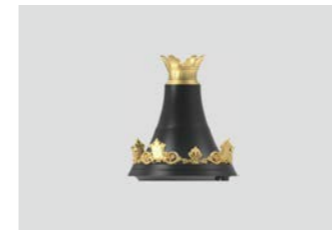
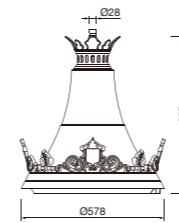

T-92SF

Code	Power	LED Qty	Optics	Packing Size	Weight	Pcs/20"	Pcs/40"
LED chips - 3535/5050							
T-92SFLED60-36 A2	60W	36	T1/T2A/T3A/T4A	500*500*480	11.2	176	384
T-92SFLED75-36 A2	75W	36	T1/T2A/T3A/T4A	500*500*480	11.2	176	384
T-92SFLED100-36 A2	100W	36	T1/T2A/T3A/T4A	500*500*480	11.5	176	384

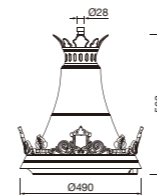

可选配件 Accessories options

		Code
	接杆组件 Connect Adaptor	250000460
	顶冠 Top Crown	210004696
	小花冠组件 Small Crown Part	210004700
	大花冠组件 Large Crown Part	210004698



T-91

KLED

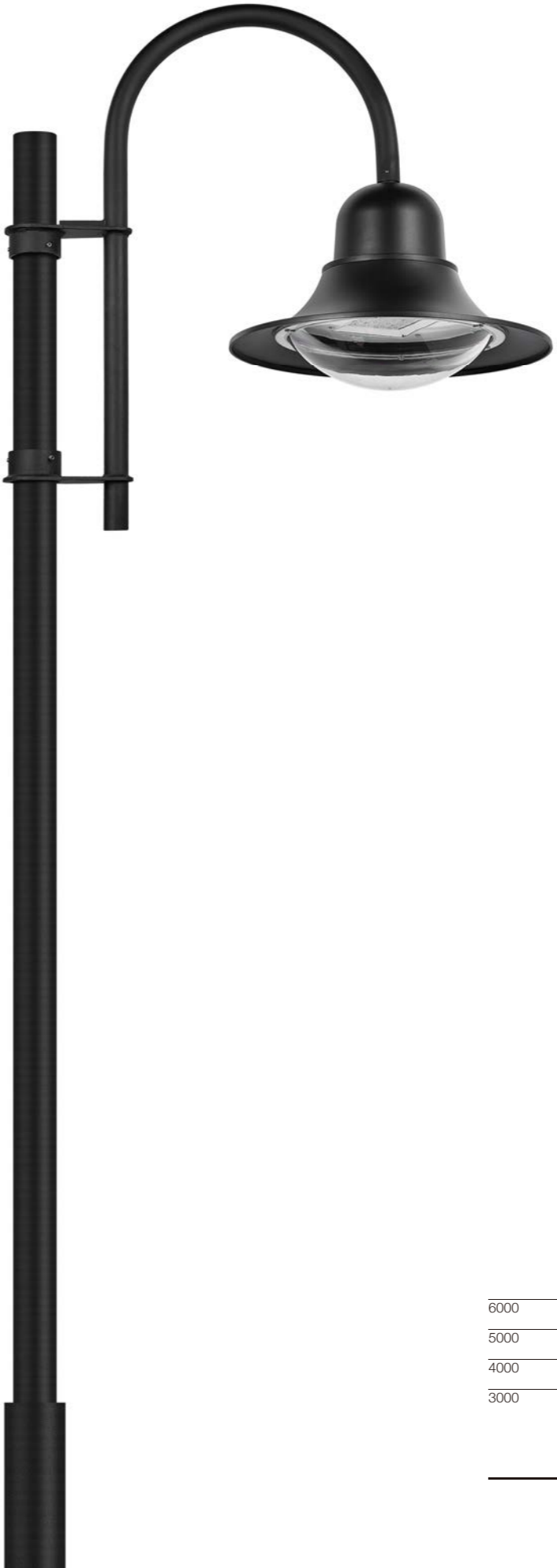

T-91
30-75W

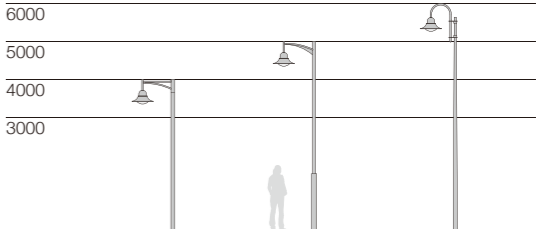

简述 Description



- 铝压铸灯体外壳，PC透明塑料罩，镀铬塑料反射罩
- 高透光PC透镜，具有高视觉舒适性和均匀配光透镜，供多种不同配光选择
- 高性能LED芯片，驱动有0-10V / DALI / 编程电源选择，20KV浪涌保护器
- 灯具采用LED模组，安装更换方便
- 防紫外线聚氨酯塑料喷涂表面，盐雾测试可以达1000小时以上
- 无生物蓝光危害风险，符合EN62471: 2008标准
- 道路灯智能远程控制系统可选，可以与远程管理系统兼容
- 所有外部螺钉均为304不锈钢材质

- Die-casting aluminium body, PC transparent diffuser, Chrome plastic reflector.
- Optics with PC lens with high visual comfortable and uniform lighting distribution, multiple light distribution options.
- High quality LED chips, Driver with 0-10V/DALI/programmed options, and with surge protection up to 20KV.
- LED module is used inside, which is easy to install and replace.
- Surface anti-ultraviolet pure polyester powder painting, Corrosion resistance can be more than 1000 hours.
- No photo-biological risk, (no risk linked to infrared, blue light and UV radiation) in accordance with EN 62471:2008.
- Street lighting control used with smart control technology. It can be compatible with remote management system.
- All external screws are made of 304 stainless steel.



MD-06 LED Module

应用透镜 Optics application

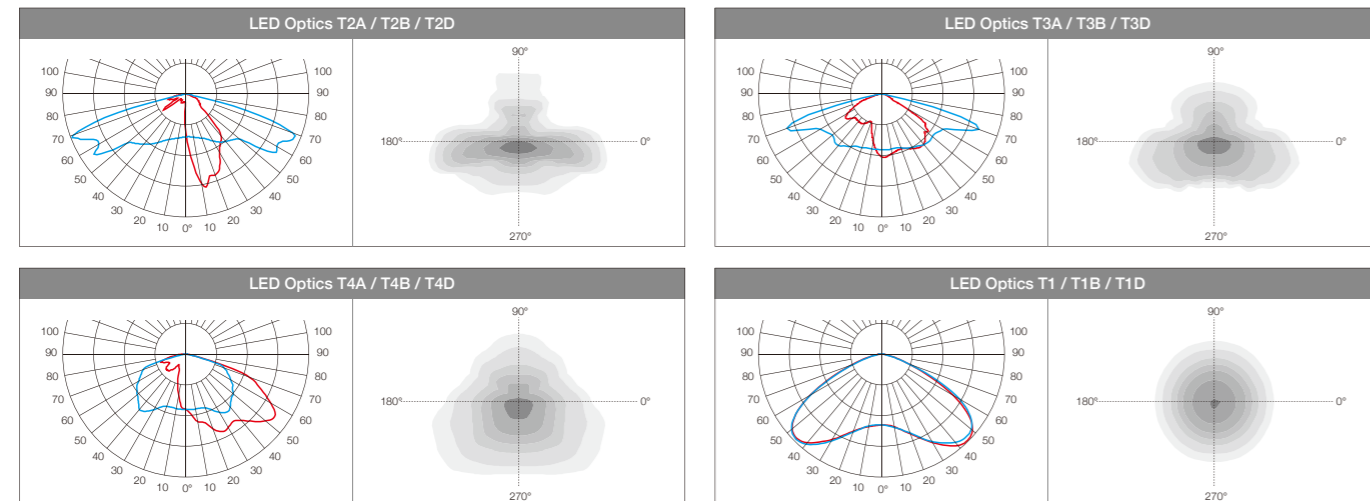

技术参数 Technology data

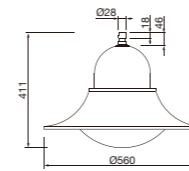

T-91

Code	Power	LED Qty	Optics	Packing Size	Weight	Pcs/20"	Pcs/40"
LED chips - 3535/5050							
T-91LED30-12	30W	12	T1/T2A/T3A/T4A	575*575*350	6.8	240	480
T-91LED40-16	40W	16	T1/T2A/T3A/T4A	575*575*350	6.8	240	480
T-91LED60-24	60W	24	T1/T2A/T3A/T4A	575*575*350	6.8	240	480
T-91LED75-32	75W	32	T1/T2A/T3A/T4A	575*575*350	6.8	240	480
LED chips - 3030							
T-91LED40-42	40W	42	T1B/T2B/T3B/T4B	575*575*350	6.8	240	480
T-91LED60-84	60W	84	T1B/T2B/T3B/T4B	575*575*350	6.8	240	480

可选配件 Accessories options

	Code
防水连接器 IP68 Connector	320000047
吊装接头 Lifting Joint	250000101



T-85 Series



T-85MN
30-75W



T-85M
30-75W



T-85MW
30-75W

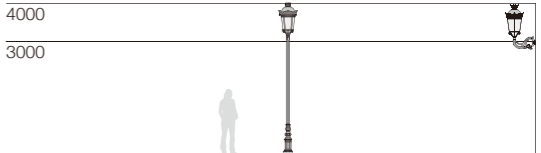

简述 Description



- 铝压铸灯体外壳，超白钢化玻璃，镀铬塑料反射罩，PMMA塑料扩散罩可选
- 高透光PC透镜，具有高视觉舒适性和均匀配光透镜，供多种不同配光选择
- 高性能LED芯片，驱动有0-10V / DALI / 编程电源选择，20KV浪涌保护器
- 古典式外形设计，配有多种安装支架及不同安装方式
- 灯具采用LED模组，安装更换方便
- 防紫外线聚氨酯粉末喷涂表面，盐雾测试可达1000小时以上
- 无生物蓝光危害风险，符合EN62471: 2008标准
- 道路灯智能远程控制可选，可以与远程管理系统兼容
- 所有外部螺钉均为304不锈钢材质



MD-06A LED Module

- Die-casting aluminium body, super white tempered glass, Chrome plastic reflector, PMMA plastic diffuser optional.
- Optics with PC lens with high visual comfortable and uniform lighting distribution, multiple light distribution options.
- High quality LED chips, Driver with 0-10V/DALI/programmed options, and with surge protection up to 20KV.
- Classical shape design, with a variety of mounting brackets and different installation methods.
- LED module is used inside, which is easy to install and replace.
- Surface anti-ultraviolet pure polyester powder painting, Corrosion resistance can be more than 1000 hours.
- No photo-biological risk, (no risk linked to infrared, blue light and UV radiation) in accordance with EN 62471:2008.
- Street lighting control used with smart control technology. It can be compatible with remote management system.
- All external screws are made of 304 stainless steel.

应用透镜 Optics application

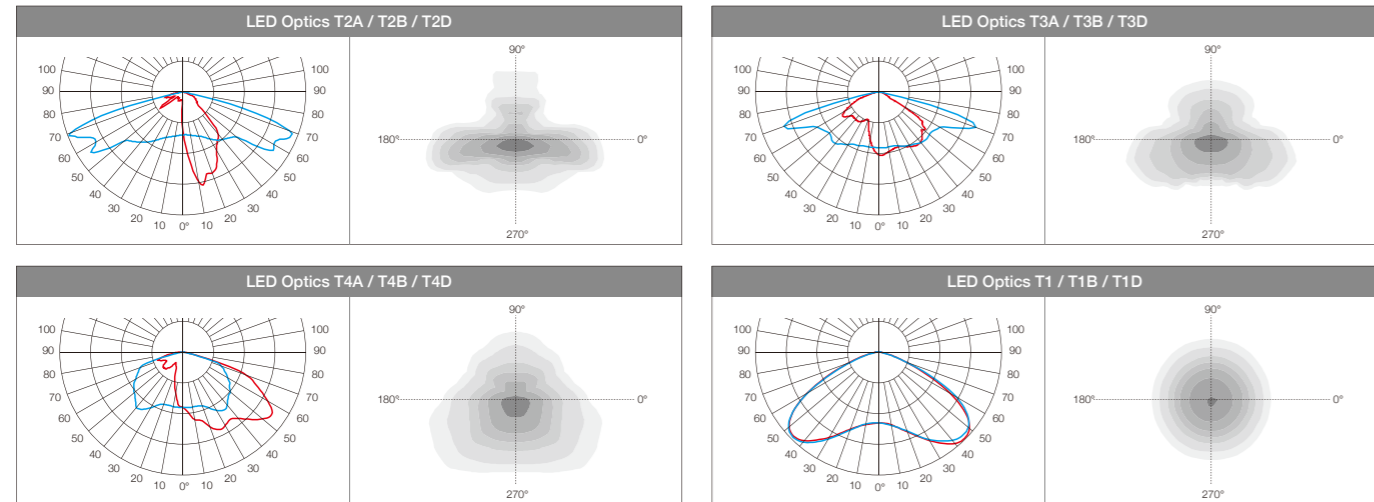

技术参数 Technology data

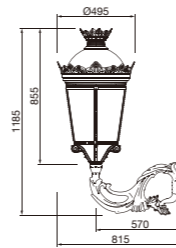
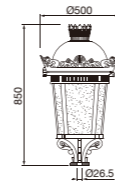
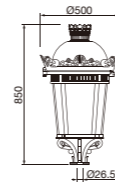

T-85MN

Code	Power	LED Qty	Optics	Packing Size	Weight	Pcs/20"	Pcs/40"
LED chips - 3535/5050							
T-85MNLED30-12	30W	12	T1/T2A/T3A/T4A	495*495*895	11.5	112	236
T-85MNLED40-16	40W	16	T1/T2A/T3A/T4A	495*495*895	11.5	112	236
T-85MNLED60-24	60W	24	T1/T2A/T3A/T4A	495*495*895	11.7	112	236
T-85MNLED75-32	75W	32	T1/T2A/T3A/T4A	495*495*895	11.7	112	236

T-85M

LED chips - 3030							
T-85MLED40-42	40W	42	T1B/T2B/T3B/T4B	495*495*895	11.5	112	236
T-85MLED60-84	60W	84	T1B/T2B/T3B/T4B	495*495*895	11.7	112	236

T-85M

Code	Power	LED Qty	Optics	Packing Size	Weight	Pcs/20"	Pcs/40"
LED chips - 3535/5050							
T-85MLED30-12	30W	12	T1/T2A/T3A/T4A	495*495*895	11.5	112	236
T-85MLED40-16	40W	16	T1/T2A/T3A/T4A	495*495*895	11.5	112	236
T-85MLED60-24	60W	24	T1/T2A/T3A/T4A	495*495*895	11.7	112	236
T-85MLED75-32	75W	32	T1/T2A/T3A/T4A	495*495*895	11.7	112	236

T-85M

LED chips - 3030							
T-85MLED40-42	40W	42	T1B/T2B/T3B/T4B	495*495*895	11.5	112	236
T-85MLED60-84	60W	84	T1B/T2B/T3B/T4B	495*495*895	11.7	112	236

T-85MW

Code	Power	LED Qty	Optics	Packing Size	Weight	Pcs/20"	Pcs/40"
LED chips - 3535/5050							
T-85MWLED30-12	30W	12	T1/T2A/T3A/T4A	495*495*895	14.5	88	190
T-85MWLED40-16	40W	16	T1/T2A/T3A/T4A	495*495*895	14.5	88	190
T-85MWLED60-24	60W	24	T1/T2A/T3A/T4A	495*495*895	14.5	88	190
T-85MWLED75-32	75W	32	T1/T2A/T3A/T4A	495*495*895	14.5	88	190

T-85MW

LED chips - 3030							
T-85MWLED40-42	40W	42	T1B/T2B/T3B/T4B	495*495*895	14.5	88	190
T-85MWLED60-84	60W	84	T1B/T2B/T3B/T4B	495*495*895	14.5	88	190

Bracket:
620*340*485/5pcs

可选配件 Accessories options

	Code
防水连接器 IP68 Connector	320000047
透明罩 Transparent PC diffuser	210000197
钻石透明罩 Diamond PC diffuser	210000198
3/4"铜接头 Copper Screw	250000093 250000094
Ø60安装座 Fixing Arm	210000431
安装花臂 Fixing Arm	250000467

Adapter required for install on the pole.





T-75MN
30-75W



T-75MS
30-75W



T-75MI
30-75W



T-75MW
30-75W

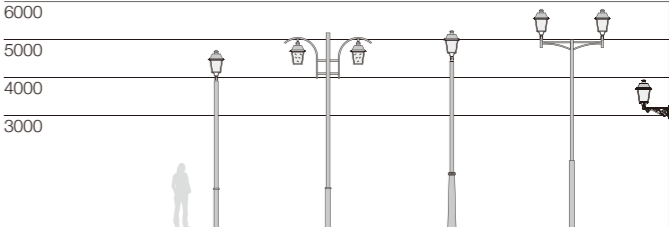

简述 Description



- 铝压铸灯体外壳，超白钢化玻璃，镀铬塑料反射罩，PMMA塑料扩散罩可选
- 高透光PC透镜，具有高视觉舒适性和均匀配光透镜，供多种不同配光选择
- 高性能LED芯片，驱动有0-10V / DALI / 编程电源选择，20KV浪涌保护器
- 古典式外形设计，配有多种安装支架及不同安装方式
- 灯具采用LED模组，安装更换方便
- 防紫外线聚氨酯粉末喷涂表面，盐雾测试可达1000小时以上
- 无生物蓝光危害风险，符合EN62471: 2008标准
- 道路灯智能远程控制系统可选，可以与远程管理系统兼容
- 所有外部螺钉均为304不锈钢材质



MD-06A LED Module

- Die-casting aluminium body, super white tempered glass, Chrome plastic reflector, PMMA plastic diffuser optional.
- Optics with PC lens with high visual comfortable and uniform lighting distribution, multiple light distribution options.
- High quality LED chips, Driver with 0-10V/DALI/programmed options, and with surge protection up to 20KV.
- Classical shape design, with a variety of mounting brackets and different installation methods.
- LED module is used inside, which is easy to install and replace.
- Surface anti-ultraviolet pure polyester powder painting, Corrosion resistance can be more than 1000 hours.
- No photo-biological risk, (no risk linked to infrared, blue light and UV radiation) in accordance with EN 62471:2008.
- Street lighting control used with smart control technology. It can be compatible with remote management system.
- All external screws are made of 304 stainless steel.

应用透镜 Optics application

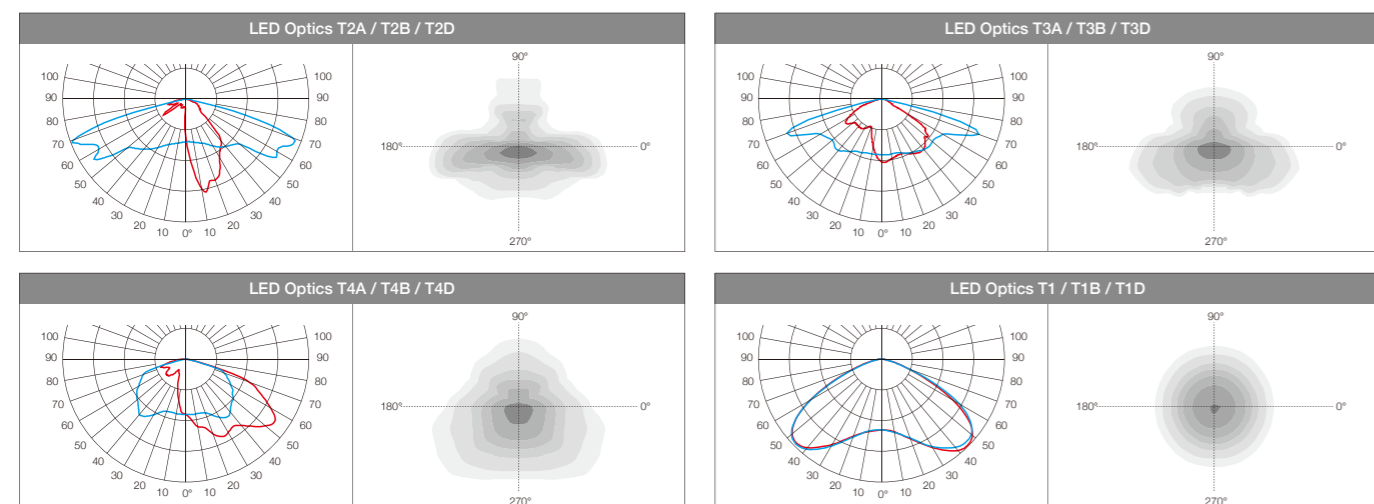

技术参数 Technology data

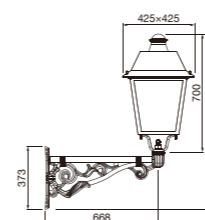
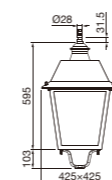
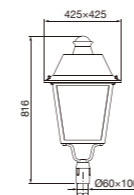

T-75MI

Code	Power	LED Qty	Optics	Packing Size	Weight	Pcs/20"	Pcs/40"
LED chips - 3535/5050							
T-75MILED30-12	30W	12	T1/T2A/T3A/T4A	445*445*665	10.3	195	490
T-75MILED40-16	40W	16	T1/T2A/T3A/T4A	445*445*665	10.3	195	490
T-75MILED60-24	60W	24	T1/T2A/T3A/T4A	445*445*665	10.5	195	490
T-75MILED75-32	75W	32	T1/T2A/T3A/T4A	445*445*665	10.5	195	490

LED chips - 3030

T-75MILED40-42	40W	42	T1B/T2B/T3B/T4B	445*445*665	10.3	195	490
T-75MILED60-84	60W	84	T1B/T2B/T3B/T4B	445*445*665	10.5	195	490

T-75MS

Code	Power	LED Qty	Optics	Packing Size	Weight	Pcs/20"	Pcs/40"
LED chips - 3535/5050							
T-75MSLED30-12	30W	12	T1/T2A/T3A/T4A	445*445*665	10.3	195	490
T-75MSLED40-16	40W	16	T1/T2A/T3A/T4A	445*445*665	10.3	195	490
T-75MSLED60-24	60W	24	T1/T2A/T3A/T4A	445*445*665	10.5	195	490
T-75MSLED75-32	75W	32	T1/T2A/T3A/T4A	445*445*665	10.5	195	490

LED chips - 3030

T-75MSLED40-42	40W	42	T1B/T2B/T3B/T4B	445*445*665	10.3	195	490
T-75MSLED60-84	60W	84	T1B/T2B/T3B/T4B	445*445*665	10.5	195	490

T-75MW

Code	Power	LED Qty	Optics	Packing Size	Weight	Pcs/20"	Pcs/40"
LED chips - 3535/5050							
T-75MWLED30-12	30W	12	T1/T2A/T3A/T4A	445*445*665	14.0	150	415
T-75MWLED40-16	40W	16	T1/T2A/T3A/T4A	445*445*665	14.0	150	415
T-75MWLED60-24	60W	24	T1/T2A/T3A/T4A	445*445*665	14.0	150	415
T-75MWLED75-32	75W	32	T1/T2A/T3A/T4A	445*445*665	14.0	150	415

LED chips - 3030

T-75MWLED40-42	40W	42	T1B/T2B/T3B/T4B	445*445*665	14.0	150	415
T-75MWLED60-84	60W	84	T1B/T2B/T3B/T4B	445*445*665	14.0	150	415

Bracket:
750*520*270/6pcs

简述 Description



- 镀锌铁板焊接外壳，超白钢化玻璃，镀铬塑料反射罩，PMMA塑料扩散罩可选
- 高透光PC透镜，具有高视觉舒适性和均匀配光透镜，供多种不同配光选择
- 高性能LED芯片，驱动有0-10V / DALI / 编程电源选择，20KV浪涌保护器
- 古典式外形设计，配有多种安装支架及不同安装方式
- 灯具采用LED模组，安装更换方便
- 防紫外线聚氨酯粉喷涂表面，盐雾测试可以达1000小时以上
- 无生物蓝光危害风险，符合EN62471: 2008标准
- 道路灯智能远程控制系统可选，可以与远程管理系统兼容
- 所有外部螺钉均为304不锈钢材质



MD-06A LED Module

- The housing made by galvanized stell plate welding, super white tempered glass, Chrome plastic reflector, PMMA plastic diffuser optional.
- Optics with PC lens with high visual comfortable and uniform lighting distribution, multiple light distribution options.
- High quality LED chips, Driver with 0-10V/DALI/programmed options, and with surge protection up to 20KV.
- Classical shape design, with a variety of mounting brackets and different installation methods.
- LED module is used inside, which is easy to install and replace.
- Surface anti-ultraviolet pure polyester powder painting, Corrosion resistance can be more than 1000 hours.
- No photo-biological risk, (no risk linked to infrared, blue light and UV radiation) in accordance with EN 62471:2008.
- Street lighting control used with smart control technology. It can be compatible with remote management system.
- All external screws are made of 304 stainless steel.

应用透镜 Optics application

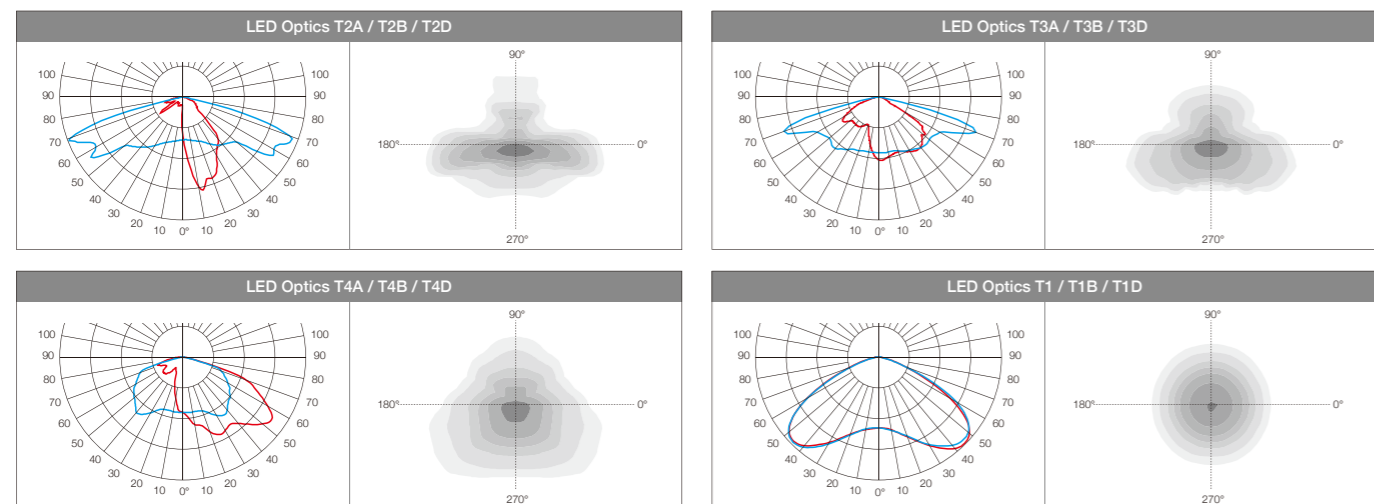

技术参数 Technology data

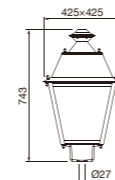

T-75MN

Code	Power	LED Qty	Optics	Packing Size	Weight	Pcs/20"	Pcs/40"
LED chips - 3535/5050							
T-75MNLED30-12	30W	12	T1/T2A/T3A/T4A	440*440*410	10	325	675
T-75MNLED40-16	40W	16	T1/T2A/T3A/T4A	440*440*410	10	325	675
T-75MNLED60-24	60W	24	T1/T2A/T3A/T4A	440*440*410	10	325	675
T-75MNLED75-32	75W	32	T1/T2A/T3A/T4A	440*440*410	10	325	675

LED chips - 3030

T-75MNLED40-42	40W	42	T1B/T2B/T3B/T4B	440*440*410	10	325	675
T-75MNLED60-84	60W	84	T1B/T2B/T3B/T4B	440*440*410	10	325	675

T-75MN



灯体外壳采用镀锌铁板焊接而成
The housing made by galvanized stell plate welding.

T-75MI



灯体外壳采用铝合金压铸而成
The housing made by aluminium.

可选配件 Accessories options

	Code
防水连接器 IP68 Connector	320000047
3/4"铜接头 Copper Screw	250000093 250000094
透明罩 PC diffuser for T-75MN for T-75MI	220000323 210000308
Ø60安装座 Fixing Arm	210000431
安装花臂 Fixing Arm Adapter required for install on the pole.	250000466



T-02 Series



T-02
30-75W

T-02B
40-60W

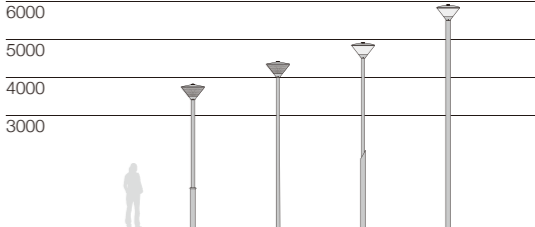

简述 Description



- 铝压铸灯体外壳，有PC透明罩和PC棱纹透明罩供选择
- 高透光PC透镜，具有高视觉舒适性和均匀配光透镜，供多种不同配光选择
- 高性能LED芯片，驱动有0-10V / DALI / 编程电源选择，20KV浪涌保护器
- 灯具光源有2种不同配置方式，独立模组式和模组透镜、光源圆呈周布置形式
- 防紫外线聚氨酯粉末喷涂表面，盐雾测试可以达1000小时以上
- 无生物蓝光危害风险，符合EN62471: 2008标准
- 道路灯智能远程控制系统可选，可以与远程管理系统兼容
- 所有外部螺钉均为304不锈钢材质



MD-06 LED Module

- Die-casting aluminium body, there are PC transparent diffuser and PC prism transparent diffuser optional.
- Optics with PC lens with high visual comfortable and uniform lighting distribution, multiple light distribution options.
- High quality LED chips, Driver with 0-10V/DALI/programmed options, and with surge protection up to 20KV.
- There are two different configuration: Moduler and module lens with light source circle are arranged in a circular form.
- Surface anti-ultraviolet pure polyester powder painting, Corrosion resistance can be more than 1000 hours.
- No photo-biological risk, (no risk linked to infrared, blue light and UV radiation) in accordance with EN 62471:2008.
- Street lighting control used with smart control technology. It can be compatible with remote management system.
- All external screws are made of 304 stainless steel.

应用透镜 Optics application



技术参数 Technology data

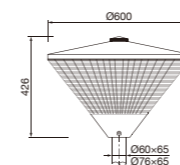

T-02

Code	Power	LED Qty	Optics	Packing Size	Weight	Pcs/20"	Pcs/40"
LED chips - 3535/5050							
T-02LED30-12	30W	12	T1/T2A/T3A/T4A	620*620*460	10.2	135	285
T-02LED40-16	40W	16	T1/T2A/T3A/T4A	620*620*460	10.3	135	285
T-02LED60-24	60W	24	T1/T2A/T3A/T4A	620*620*460	10.3	135	285
T-02LED75-32	75W	32	T1/T2A/T3A/T4A	620*620*460	10.5	135	285

LED chips - 3030

T-02LED40-42	40W	42	T1B/T2B/T3B/T4B	620*620*460	10.3	135	285
T-02LED60-84	60W	84	T1B/T2B/T3B/T4B	620*620*460	10.3	135	285

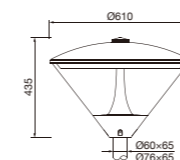

T-02B

Code	Power	LED Qty	Optics	Packing Size	Weight	Pcs/20"	Pcs/40"
LED chips - 2835							
T-02BLED40-128	40W	128	T32B	620*620*460	10.3	135	285
T-02BLED60-128	60W	128	T32B	620*620*460	10.3	135	285

可选配件 Accessories options

	Code
	防水连接器 IP68 Connector 32000047
	Ø76-60转换套 Adapter 210001154 Arm / Adapter required for install on the pole.



T-01



T-01
30-75W

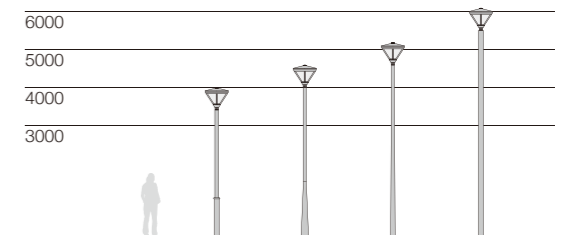

简述 Description



- 铝压铸灯体外壳, PC透明塑料罩, 镀铬塑料反射罩
- 高透光PC透镜, 具有高视觉舒适性和均匀配光透镜, 供多种不同配光选择
- 高性能LED芯片, 驱动有0-10V / DALI / 编程电源选择, 20KV浪涌保护器
- 灯具采用LED模组, 安装更换方便
- 防紫外线聚氨酯塑粉喷涂表面, 盐雾测试可以达1000小时以上
- 无生物蓝光危害风险, 符合EN62471: 2008标准
- 道路灯智能远程控制系统可选, 可以与远程管理系统兼容
- 所有外部螺钉均为304不锈钢材质



MD-06 LED Module

- Die-casting aluminium body, PC transparent diffuser, Chrome plastic reflector.
- Optics with PC lens with high visual comfortable and uniform lighting distribution, multiple light distribution options.
- High quality LED chips, Driver with 0-10V/DALI/programmed options, and with surge protection up to 20KV.
- LED module is used inside, which is easy to install and replace.
- Surface anti-ultraviolet pure polyester powder painting, Corrosion resistance can be more than 1000 hours.
- No photo-biological risk, (no risk linked to infrared, blue light and UV radiation) in accordance with EN 62471:2008.
- Street lighting control used with smart control technology. It can be compatible with remote management system.
- All external screws are made of 304 stainless steel.

应用透镜 Optics application

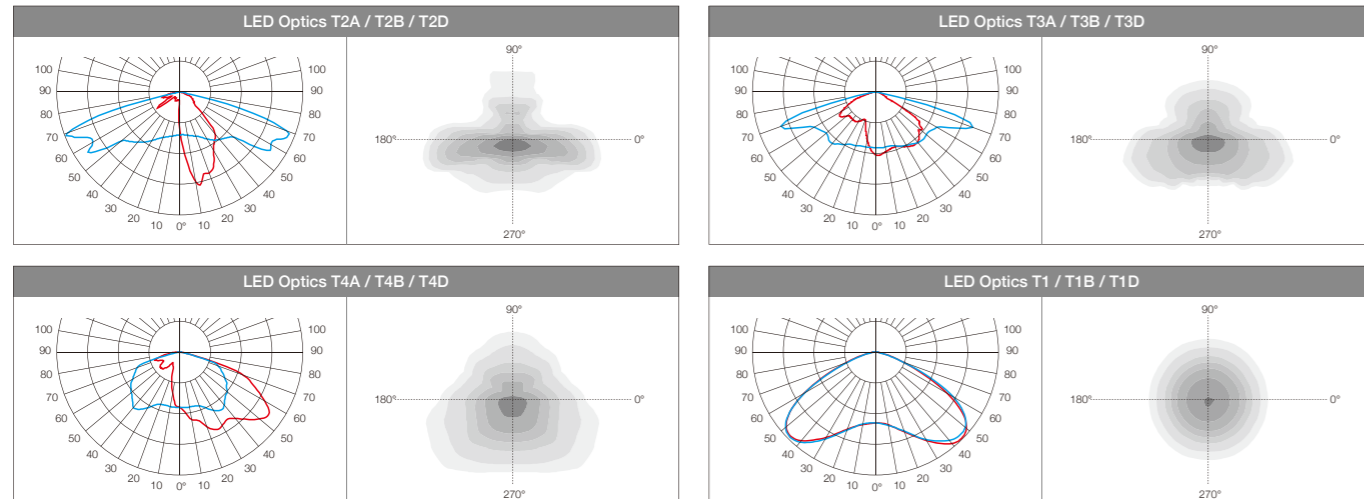

技术参数 Technology data

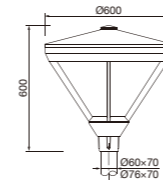

T-01

Code	Power	LED Qty	Optics	Packing Size	Weight	Pcs/20"	Pcs/40"
LED chips - 3535/5050							
T-01LED30-12	30W	12	T1/T2A/T3A/T4A	615*615*580	12.0	81	171
T-01LED40-16	40W	16	T1/T2A/T3A/T4A	615*615*580	12.1	81	171
T-01LED60-24	60W	24	T1/T2A/T3A/T4A	615*615*580	12.1	81	171
T-01LED75-32	75W	32	T1/T2A/T3A/T4A	615*615*580	12.3	81	171
LED chips - 3030							
T-01LED40-42	40W	42	T1B/T2B/T3B/T4B	615*615*580	12.1	81	171
T-01LED60-84	60W	84	T1B/T2B/T3B/T4B	615*615*580	12.1	81	171

可选配件 Accessories options

	Code
防水连接器 IP68 Connector	320000047
Ø76-60转换套 Adapter Arm / Adapter required for install on the pole.	210001154



T-70 Series

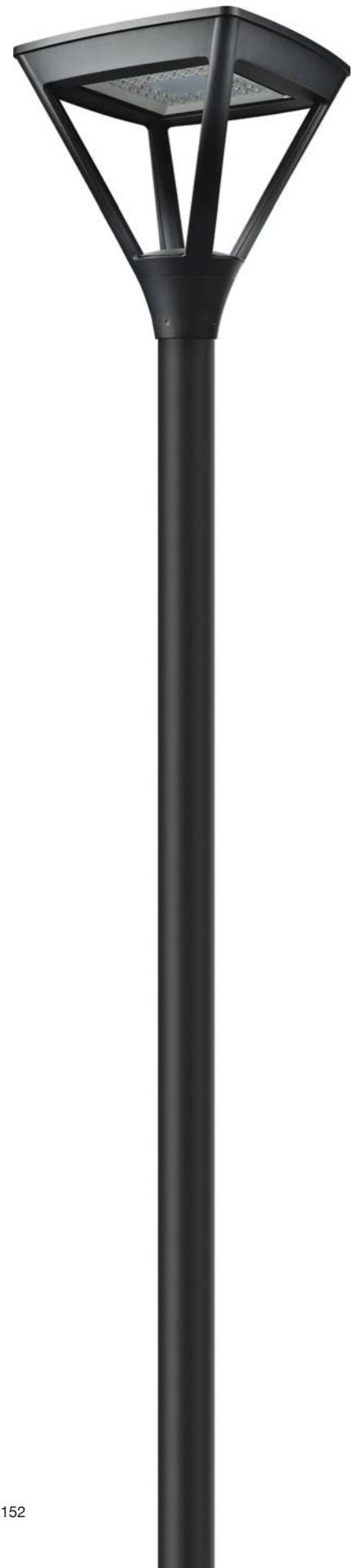

T-70N
40-100W



T-70S
30-60W



T-70 Series

一组经典设计LED庭院灯具，灯具外形呈四方锥形设计，把古典建筑美感融入到现代设计理念中，体现着现代城市夜景的不朽传奇。

A classic design led garden lighting, which shape is square cone design, the classical architectural beauty into the modern design concept, reflecting the immortal legend of modern city night scene.

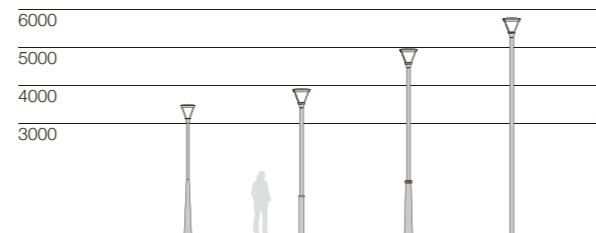

简述 Description



- 铝压铸灯体外壳，超白钢化玻璃，白色塑料反射罩
- 高透光PC透镜，具有高视觉舒适性和均匀配光透镜，供多种不同配光选择
- 高性能LED芯片，驱动有0-10V / DALI / 编程电源选择，20KV浪涌保护器
- 有2款尺寸可选择，安装管径有Ø60 / Ø76mm
- 防紫外线聚氨酯粉末喷涂表面，盐雾测试可以达1000小时以上
- 无生物蓝光危害风险，符合EN62471: 2008标准
- 道路灯智能远程控制系统可选，可以与远程管理系统兼容
- 所有外部螺钉均为304不锈钢材质

- Die-casting aluminium body, super white tempered glass, white PC plastic reflector.
- Optics with PC lens with high visual comfortable and uniform lighting distribution, multiple light distribution options.
- High quality LED chips, Driver with 0-10V/DALI/programmed be options, and with surge protection up to 20KV.
- There are two sizes options, installation tube diameter Ø60/Ø76mm.
- Surface anti-ultraviolet pure polyester powder painting, Corrosion resistance can be more than 1000 hours.
- No photo-biological risk, (no risk linked to infrared, blue light and UV radiation) in accordance with EN 62471:2008.
- Street lighting control used with smart control technology. It can be compatible with remote management system.
- All external screws are made of 304 stainless steel.

T-70N



灯具采用一体式灯体结构，整体PCB板结构设计，其最大功率100W

By Integrated lamp body structure, integrated PCB structure design, which maximum power of 100W.



T-70S



采用分体式灯体结构，Zhaga标准PCB设计，其最大功率60W

By Split lamp body structure, with zhaga standard PCB design, which maximum power 60W.

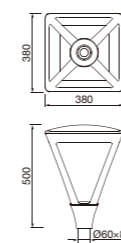

应用透镜 Optics application

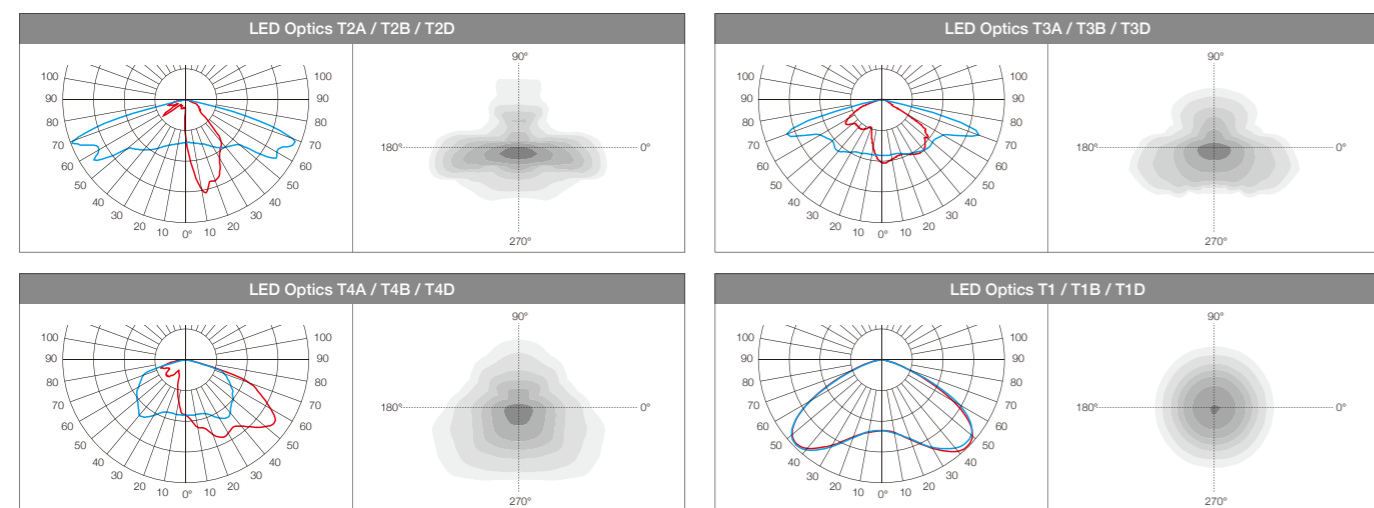

技术参数 Technology data

T-70N

Code	Power	LED Qty	Optics	Packing Size	Weight	Pcs/20"	Pcs/40"
LED chips - 3535/5050							
T-70NLED40-32	40W	32	T1/T2A/T3A/T4A	480*480*550	13.5	176	384
T-70NLED60-32	60W	32	T1/T2A/T3A/T4A	480*480*550	13.5	176	384
T-70NLED75-48	75W	48	T1/T2A/T3A/T4A	480*480*550	13.7	176	384
T-70NLED100-48	100W	48	T1/T2A/T3A/T4A	480*480*550	13.7	176	384

LED chips - 3030

T-70NLED40-48	40W	48	T1/T2A/T3A/T4A	480*480*550	13.5	176	384
T-70NLED60-72	60W	72	T1D/T2D/T3D/T4D	480*480*550	13.5	176	384
T-70NLED75-72	75W	72	T1D/T2D/T3D/T4D	480*480*550	13.7	176	384
T-70NLED100-112	100W	112	T1B/T2B/T3B/T4B	480*480*550	13.7	176	384

T-70S

Code	Power	LED Qty	Optics	Packing Size	Weight	Pcs/20"	Pcs/40"
LED chips - 3535/5050							
T-70SLED30-16 A4	30W	16	T1A/T2A/T3A/T4A	390*390*535	9.3	323	684
T-70SLED40-24 A2	40W	24	T1A/T2A/T3A/T4A	390*390*535	9.3	323	684
T-70SLED60-24 A2	60W	24	T1A/T2A/T3A/T4A	390*390*535	9.3	323	684

LED chips - 3030

T-70SLED30-56 B4	30W	56	T1D/T2D/T3D/T4D	390*390*535	9.3	323	684
T-70SLED40-56 B4	40W	56	T1B/T2B/T3B/T4B	390*390*535	9.3	323	684
T-70SLED60-84 B3	60W	84	T1B/T2B/T3B/T4B	390*390*535	9.3	323	684

可选配件 Accessories options

	Code
防水连接器 IP68 Connector	320000047
Ø76-60转换套 Adapter	210001154
Ø60-76转接头 Pole reducer	210001465

Adapter required for install on the pole.

延伸产品 More in family

SOLAR OPTIONS



TS-70N
Solar Lighting: 12W.



T-10 Series



T-10A
25-75W



T-10B
40-60W



古典球形设计LED庭院灯，设计灵感来自地球，能使照明灯具很好的融入到自然环境中。灯具有多种光源配置形式，根据照明效果来自由选择应用。

A classical spherical design led garden lighting, it design inspiration from the earth, can make lighting and lanterns into the natural environment. This luminaire have a variety of light source configuration, according to the lighting effect to choose the application freely.

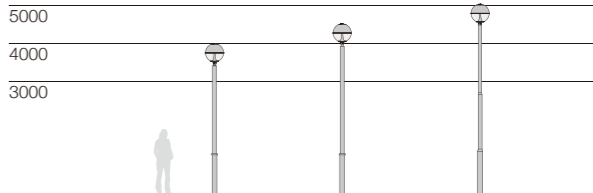

简述 Description



- 铝压铸灯体外壳，PC透明塑料罩
- 高透光PC透镜，具有高视觉舒适性和均匀配光透镜，供多种不同配光选择
- 高性能LED芯片，驱动有0-10V / DALI / 编程电源选择，20KV浪涌保护器
- 灯具光源有2种不同配置方式，独立模组式和模组透镜、光源圆呈周布置形式
- 防紫外线聚氨酯塑粉喷涂表面，盐雾测试可以达1000小时以上
- 无生物蓝光危害风险，符合EN62471: 2008标准
- 道路灯智能远程控制系统可选，可以与远程管理系统兼容
- 所有外部螺钉均为304不锈钢材质



MD-07 LED Module

- Die-casting aluminium body, PC transparent diffuser.
- Optics with PC lens with high visual comfortable and uniform lighting distribution, multiple light distribution options.
- High quality LED chips, Driver with 0-10V/DALI/programmed options, and with surge protection up to 20KV.
- There are two different configuration: Moduler and module lens with light source circle are arranged in a circular form.
- Surface anti-ultraviolet pure polyester powder painting, Corrosion resistance can be more than 1000 hours.
- No photo-biological risk, (no risk linked to infrared, blue light and UV radiation) in accordance with EN 62471:2008.
- Street lighting control used with smart control technology. It can be compatible with remote management system.
- All external screws are made of 304 stainless steel.

应用透镜 Optics application

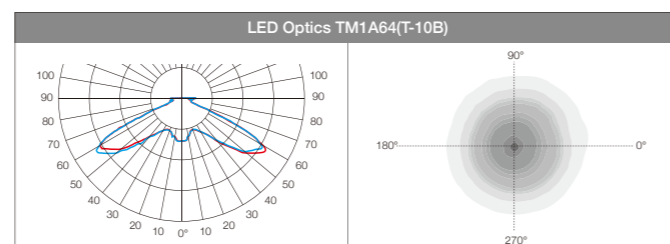
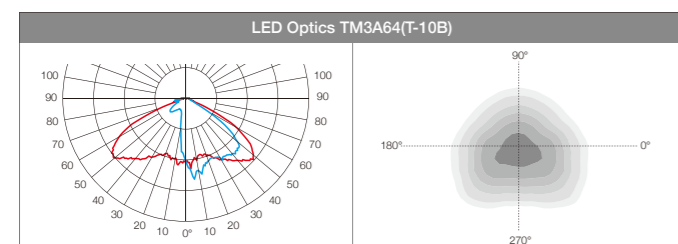
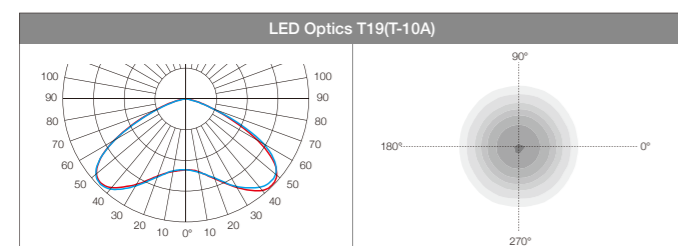

技术参数 Technology data

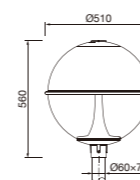

T-10A

Code	Power	LED Qty	Optics	Packing Size	Weight	Pcs/20"	Pcs/40"
LED chips - 3535/5050							
T-10ALED40-2MD07	40W	18	T19	525*525*615	10.8	176	352
T-10ALED60-4MD07	60W	36	T19	525*525*615	12.3	176	352
T-10ALED75-4MD07	75W	36	T19	525*525*615	12.3	176	352

LED chips - 3030

T-10ALED25-2MD07	25W	18	T19	525*525*615	10.8	176	352
T-10ALED40-4MD07	40W	36	T19	525*525*615	12.3	176	352

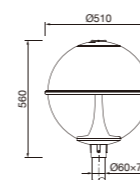
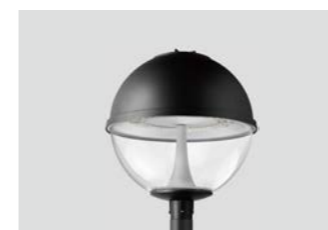

T-10B

Code	Power	LED Qty	Optics	Packing Size	Weight	Pcs/20"	Pcs/40"
LED chips - 2835							
T-10BLED40-128	40W	128	T32B	525*525*615	9.4	176	352
T-10BLED60-128	60W	128	T32B	525*525*615	9.4	176	352

T-10A



灯具采用MD-07 模组，具有2模组和4模组两个版本，安装维修方便

It with MD-07 module, it has two versions for 2 module and 4 module, which is convenient for installation and maintenance.

T-10B



LED呈圆周分布，有对称和非对称光学选项，具有非常舒适的照明效果

The LED is evenly distributed 360° around the circumference, it has symmetric and asymmetric optical options, which has a good optical visual effect.



T-05

KLED



T-05

40-75W

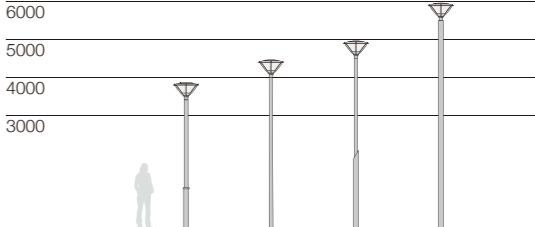

简述 Description



- 铝压铸灯体外壳，PC棱纹设计透明塑料罩
- 高透光PC透镜，具有高视觉舒适性和均匀配光透镜，供多种不同配光选择
- 高性能LED芯片，驱动有0-10V / DALI / 编程电源选择，20KV浪涌保护器
- 灯具光源设置在顶部，采用ZHAGA PCB板模组，替换方便
- 防紫外线聚氨酯塑料喷涂表面，盐雾测试可以达1000小时以上
- 无生物蓝光危害风险，符合EN62471: 2008标准
- 道路灯智能远程控制系统可选，可以与远程管理系统兼容
- 所有外部螺钉均为304不锈钢材质

- Die-casting aluminium body, PC prism transparent diffuser.
- Optics with PC lens with high visual comfortable and uniform lighting distribution, multiple light distribution options.
- High quality LED chips, Driver with 0-10V/DALI/programmed options, and with surge protection up to 20KV.
- The light source of the lighting is set at the top, and it is easy to replace by using zhaga PCB board.
- Surface anti-ultraviolet pure polyester powder painting, Corrosion resistance can be more than 1000 hours.
- No photo-biological risk, (no risk linked to infrared, blue light and UV radiation) in accordance with EN 62471:2008.
- Street lighting control used with smart control technology. It can be compatible with remote management system.
- All external screws are made of 304 stainless steel.

应用透镜 Optics application

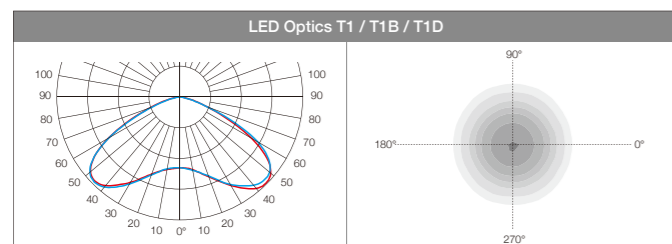

技术参数 Technology data

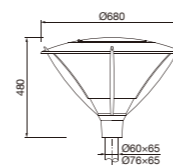

T-05

Code	Power	LED Qty	Optics	Packing Size	Weight	Pcs/20"	Pcs/40"
LED chips - 3535/5050							
T-05LED40-32	40W	32	T1	700*700*490	11.5	104	221
T-05LED60-32	60W	32	T1	700*700*490	11.5	104	221
LED chips - 3030							
T-05LED40-56	40W	56	T1D	700*700*490	11.5	104	221
T-05LED60-112	60W	112	T1B	700*700*490	11.5	104	221
T-05LED75-112	75W	112	T1B	700*700*490	11.5	104	221

光源板采用zhaga板设计，置于灯具上部向下投射，灯具散热佳，同时在光源外部增加扩散透明板，使光线更加柔和，有效解决眩光问题

The light source board adopts zhaga board design, which is placed on the upper part, it effectively solves the heat dissipation problem of the lighting, the diffusion transparent plate is added outside the light source to make the light more comfortable.

可选配件 Accessories options

	Code
防水连接器 IP68 Connector	320000047
Ø76-60转换套 Adapter Arm / Adapter required for install on the pole.	210001154





T-101 Series



T-101
50W



T-101L
50W

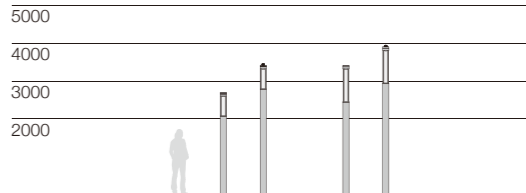

简述 Description



- 铝压铸上盖和铝合金型材灯柱，根据需要切割成不同灯杆高度，PC透明塑料罩
- 灯具配光有2种形式，顶部SMD光源加扩散罩，外加防眩格栅罩，具有很高视觉舒适性
- 驱动有0-10V / DALI / 编程电源选择，20KV浪涌保护器
- 模块式电器部件，安装更换方便
- 防紫外线聚氨酯粉末喷涂表面，盐雾测试可以达1000小时以上
- 无生物蓝光危害风险，符合EN62471: 2008标准
- 道路灯智能远程控制系统可选，可以与远程管理系统兼容
- 所有外部螺钉均为304不锈钢材质

- Die-casting aluminium top cover, extruded aluminium column pole, the height according to the client required, PC transparent diffuser.
- There are two forms of light distribution: Top SMD light source with diffusion cover and anti glare rouver.
- High quality LED chips, Driver with 0-10V/DALI/programmed options, and with surge protection up to 20KV.
- LED module is used inside, Integrated electrical components which is easy to install and replace.
- Surface anti-ultraviolet pure polyester powder painting, Corrosion resistance can be more than 1000 hours.
- No photo-biological risk, (no risk linked to infrared, blue light and UV radiation) in accordance with EN 62471:2008.
- Street lighting control used with smart control technology. It can be compatible with remote management system.
- All external screws are made of 304 stainless steel.

应用透镜 Optics application

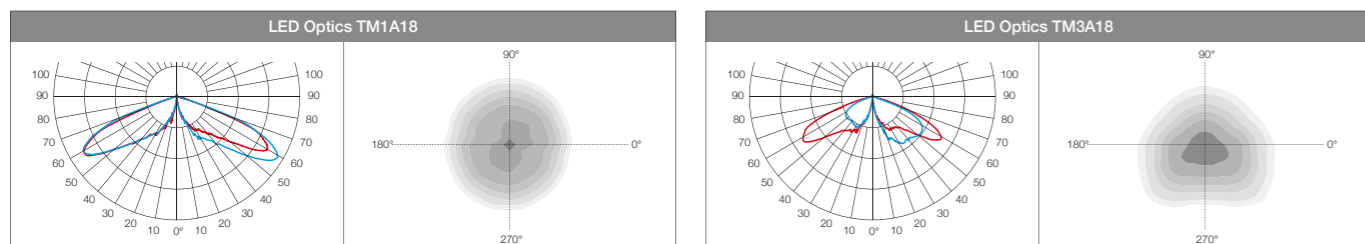

技术参数 Technology data



T-101

Code	Power	LED Qty	Optics	Packing Size	Weight	Pcs/20"	Pcs/40"
LED chips - 5050							
T-101LED50-18H270	50W	18	TM1A18/TM3A18	2750*295*295	27	98	196
T-101LED50-18H350	50W	18	TM1A18/TM3A18	Head: 1070*200*205 Pole: 2900*295*305	19	87	180



T-101L

Code	Power	LED Qty	Optics	Packing Size	Weight	Pcs/20"	Pcs/40"
LED chips - 5050							
T-101LLED50-18H350	50W	18	TM1A18/TM3A18	Head: 1410*200*205 Pole: 2550*295*305	20	88	176
T-101LLED50-18H400	50W	18	TM1A18/TM3A18	Head: 1410*200*205 Pole: 3050*295*305	11	49	147

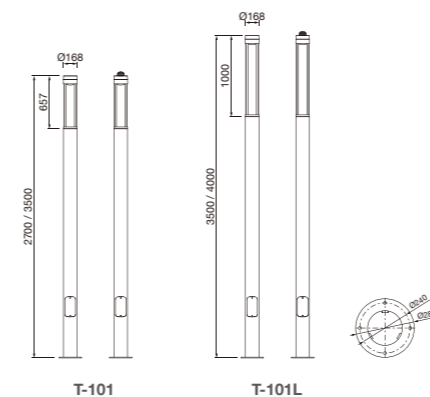

独立防水电器部件
Independent waterproof electrical components.

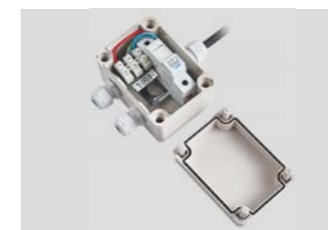

防水接线盒，内置保险断路器
Waterproof junction box with built-in fuse circuit breaker.

可选配件 Accessories options

	Code
接线盒 Junction Box	230000199
基础螺杆 Anchor Bolts	250000293





一体式智慧庭院灯
All-in-One Integrated Smart Column Lighting



一款智能化的柱形景观灯，使用包含预认证硬件的即插即用可旋转模块，可以根据您的特定需求进行配置。

A smart column lighting is a connected, modular approach to city hardware. With plug-and-play rotatable modules that contain pre-certified hardware, it can be configured to suit your specific needs.





T-102
60W

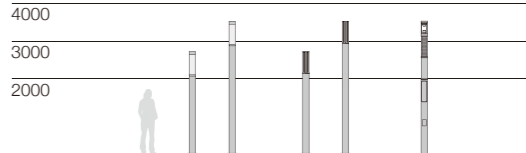

T-102SM
60W

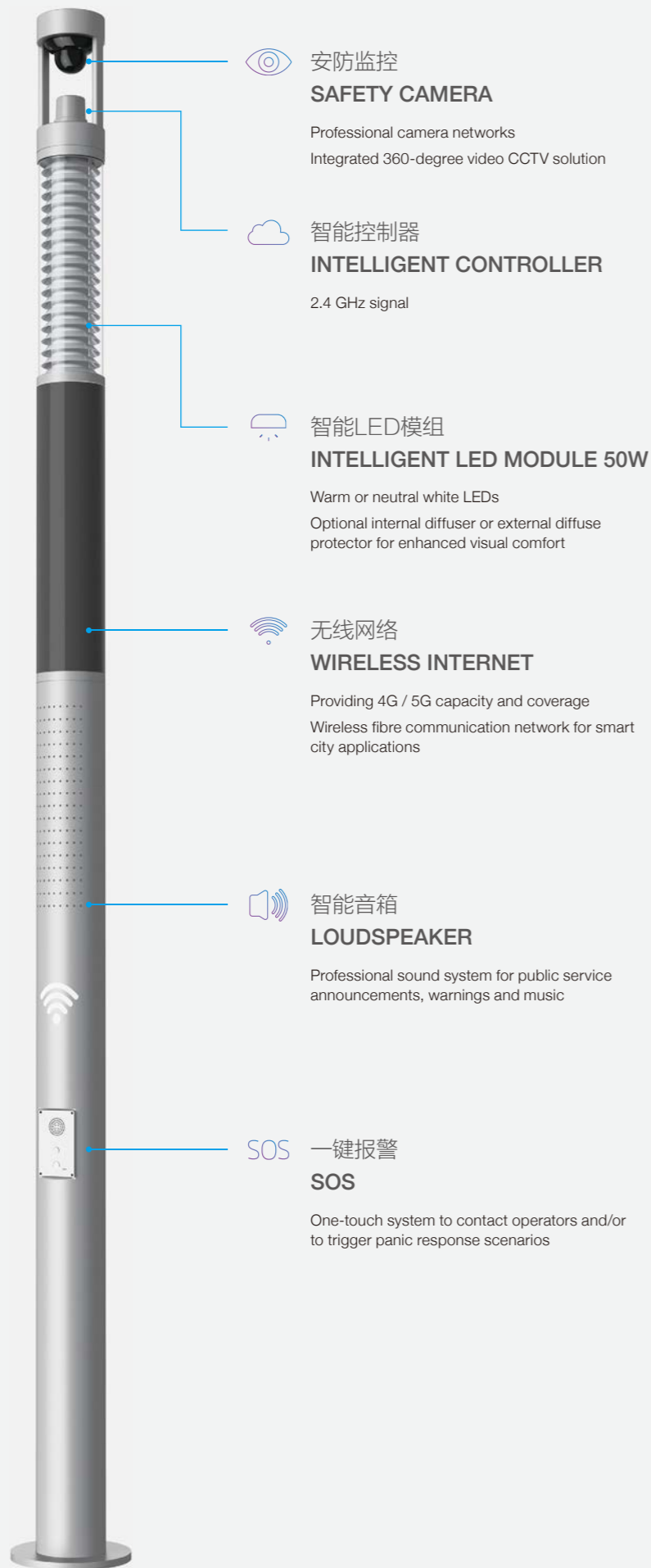

电源插座
POWER SUPPLY
Auxiliary power source
Integrated fuse



充电桩
EV CHARGING
Professional charging station
Safety locking during charging



简述 Description



- 铝压铸上盖和铝合金型材灯柱，根据需要切割成不同灯杆高度，PC透明塑料罩
- 灯具中间SMD光源加扩散罩，外加防眩格栅罩，具有很高视觉舒适性
- 驱动有0-10V / DALI / 编程电源选择，20KV浪涌保护器
- 模块式电器部件，安装更换方便
- 防紫外线聚氨酯塑粉喷涂表面，盐雾测试可以达1000小时以上
- 无生物蓝光危害风险，符合EN62471: 2008标准
- 道路灯智能远程控制系统可选，可以与远程管理系统兼容
- 所有外部螺钉均为304不锈钢材质

- Die-casting aluminium top cover, extruded aluminium column pole, the height according to the client required, PC transparent diffuser.
- There with frosted glass and middle SMD light source with diffusion cover and anti glare rouver.
- High quality LED chips, Driver with 0-10V/DALI/programmed options, and with surge protection up to 20KV.
- LED module is used inside, Integrated electrical components which is easy to install and replace.
- Surface anti-ultraviolet pure polyester powder painting, Corrosion resistance can be more than 1000 hours.
- No photo-biological risk, (no risk linked to infrared, blue light and UV radiation) in accordance with EN 62471:2008.
- Street lighting control used with smart control technology. It can be compatible with remote management system.
- All external screws are made of 304 stainless steel.

应用透镜 Optics application

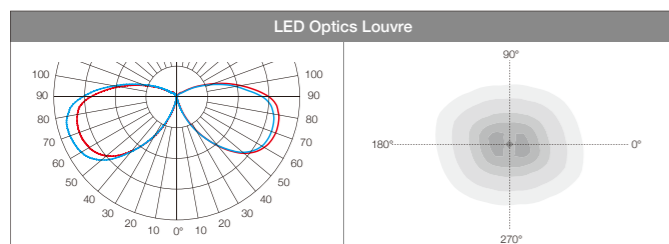

独立防水电器部件
Independent waterproof electrical components.



防水接线盒，内置保险断路器
Waterproof junction box with built-in fuse circuit breaker.

技术参数 Technology data

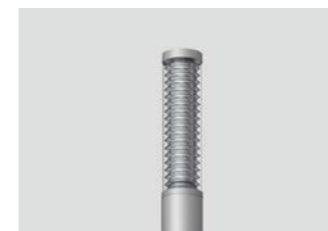

T-102

Code	Power	LED Qty	Optics	Packing Size	Weight	Pcs/20"	Pcs/40"
LED chips - 2835							
T-102LED60-576H270	60W	576	ROUVR	2750*295*295	27	98	196
T-102LED60-576H350	60W	576	ROUVR	Head: 1070*200*205 Pole: 2900*295*305	19	87	180



T-102SM

Code	Power	LED Qty	Optics	Packing Size	Weight	Pcs/20"	Pcs/40"
LED chips - 2835							
T-102SMLED60-576H350	60W	576	ROUVR	Head: 1750*200*205 Pole: 1850*295*305	22	116	246

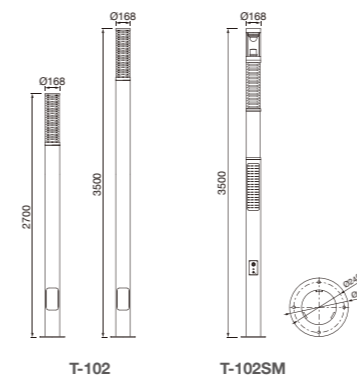

延伸产品 More in family

SOLAR OPTIONS



TS-102
Solar Lighting: 15W.

可选配件 Accessories options

	Code
接线盒 Junction Box	230000199
基础螺杆 Anchor Bolts	250000293





T-231 Series

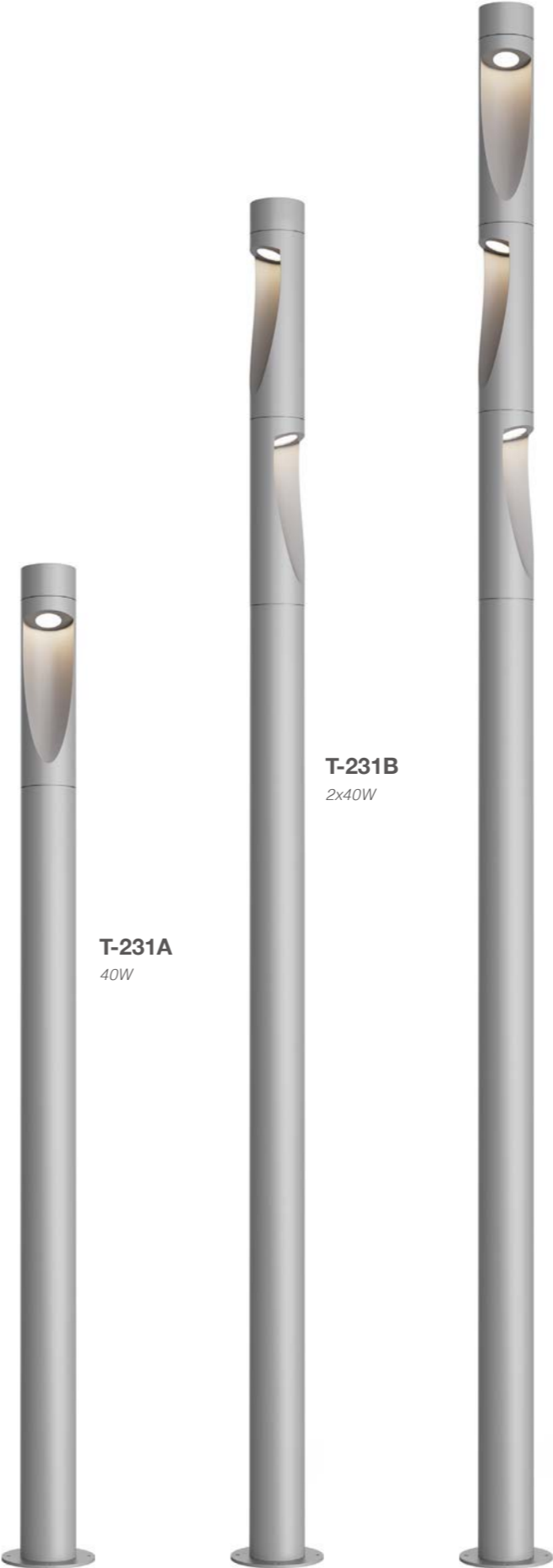

T-231A
40W

T-231B
2x40W

T-231C
3x40W



一组加入现代元素设计的模组组合式庭院灯具，灯具外形设计简洁，通过几个模组旋转组合来适应不同场所照明应用，灯具功率40W-120W。

A group of modular designed lighting with modern elements. The simple shape design. Through the combination of several module rotation angles to adapt to the lighting application, the lighting power is 40W-120W.

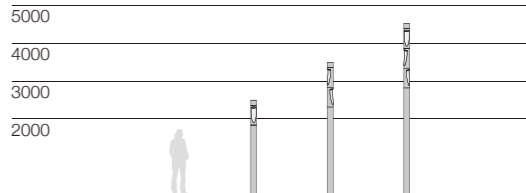

简述 Description



- 铝压铸灯体外壳，铝合金拉伸灯杆，高度根据客户要求截取
- 模组式光源模块配超白钢化玻璃，外加防眩罩，具有很高视觉舒适性
- 驱动有0-10V / DALI / 编程电源选择，20KV浪涌保护器
- 模块式电器部件，安装更换方便
- 防紫外线聚氨酯粉喷涂表面，盐雾测试可以达1000小时以上
- 无生物蓝光危害风险，符合EN62471: 2008标准
- 道路灯智能远程控制系统可选，可以与远程管理系统兼容
- 所有外部螺钉均为304不锈钢材质

- Aluminum die casting cover, extruded aluminum body, it can be cut different height.
- LED module design and with supper tempered gals, It has good visual comfortable light effect.
- High quality LED chips, Driver with 0-10V/DALI/programmed options, and with surge protection up to 20KV.
- LED module is used inside, Integrated electrical components which is easy to install and replace.
- Surface anti-ultraviolet pure polyester powder painting, Corrosion resistance can be more than 1000 hours.
- No photo-biological risk, (no risk linked to infrared, blue light and UV radiation) in accordance with EN 62471:2008.
- Street lighting control used with smart control technology. It can be compatible with remote management system.
- All external screws are made of 304 stainless steel.

应用透镜 Optics application

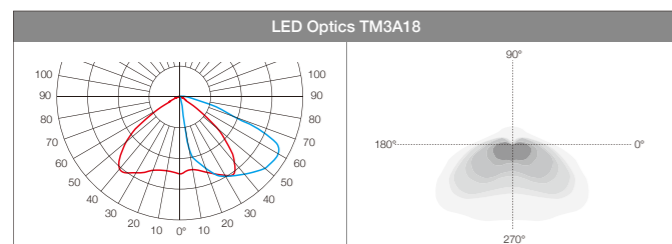

技术参数 Technology data



T-231A

Code	Power	LED Qty	Optics	Packing Size	Weight	Pcs/20"	Pcs/40"
LED chips - 5050							
T-231ALED40-18H200	40W	18	TM3A18	2050*295*295	20.5	133	280
T-231ALED40-18H250	40W	18	TM3A18	2550*295*295	25.5	98	196



T-231B

Code	Power	LED Qty	Optics	Packing Size	Weight	Pcs/20"	Pcs/40"
LED chips - 5050							
T-231BLED80-36H270	80W	36	TM3A18	2750*295*295	27	98	196
T-231BLED80-36H350	80W	36	TM3A18	Head: 1660*200*205 Pole: 2310*295*305	21 10	99	214

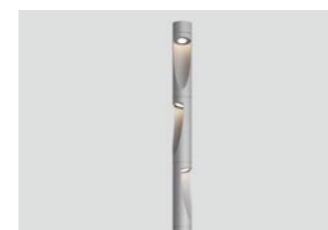

T-231C

Code	Power	LED Qty	Optics	Packing Size	Weight	Pcs/20"	Pcs/40"
LED chips - 5050							
T-231CLE120-54H350	120W	54	TM3A18	Head: 2550*200*205 Pole: 1730*295*305	22 8	100	203
T-231CLE120-54H400	120W	54	TM3A18	Head: 2550*200*205 Pole: 2230*295*305	25.5 8.5	88	176
T-231CLE120-54H450	120W	54	TM3A18	Head: 2550*200*205 Pole: 2730*295*305	29 9	74	151

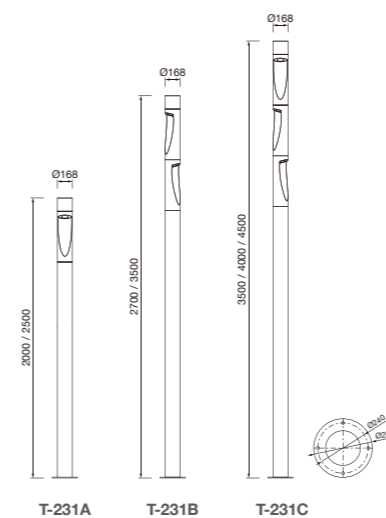

延伸产品 More in family



C-231A / C-231B

Bollard Lighting: 15W.

可选配件 Accessories options

	Code
接线盒 Junction Box	230000199
基础螺杆 Anchor Bolts	250000293





Smart Lighting

充电桩 + 安防监控 + 广告发布
Charging + Security + Advertisement



一款集多功能智能设备的景观庭院灯，灯具造型简单，可根据客户需求定制需要功能模块。



A integrated intelligent garden lighting which has multiple functions and can be customized according to the needs of customers.

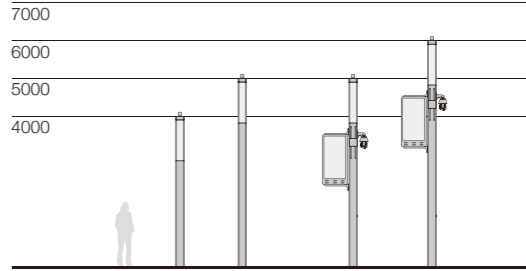

T-221
60W

T-221SM
60W

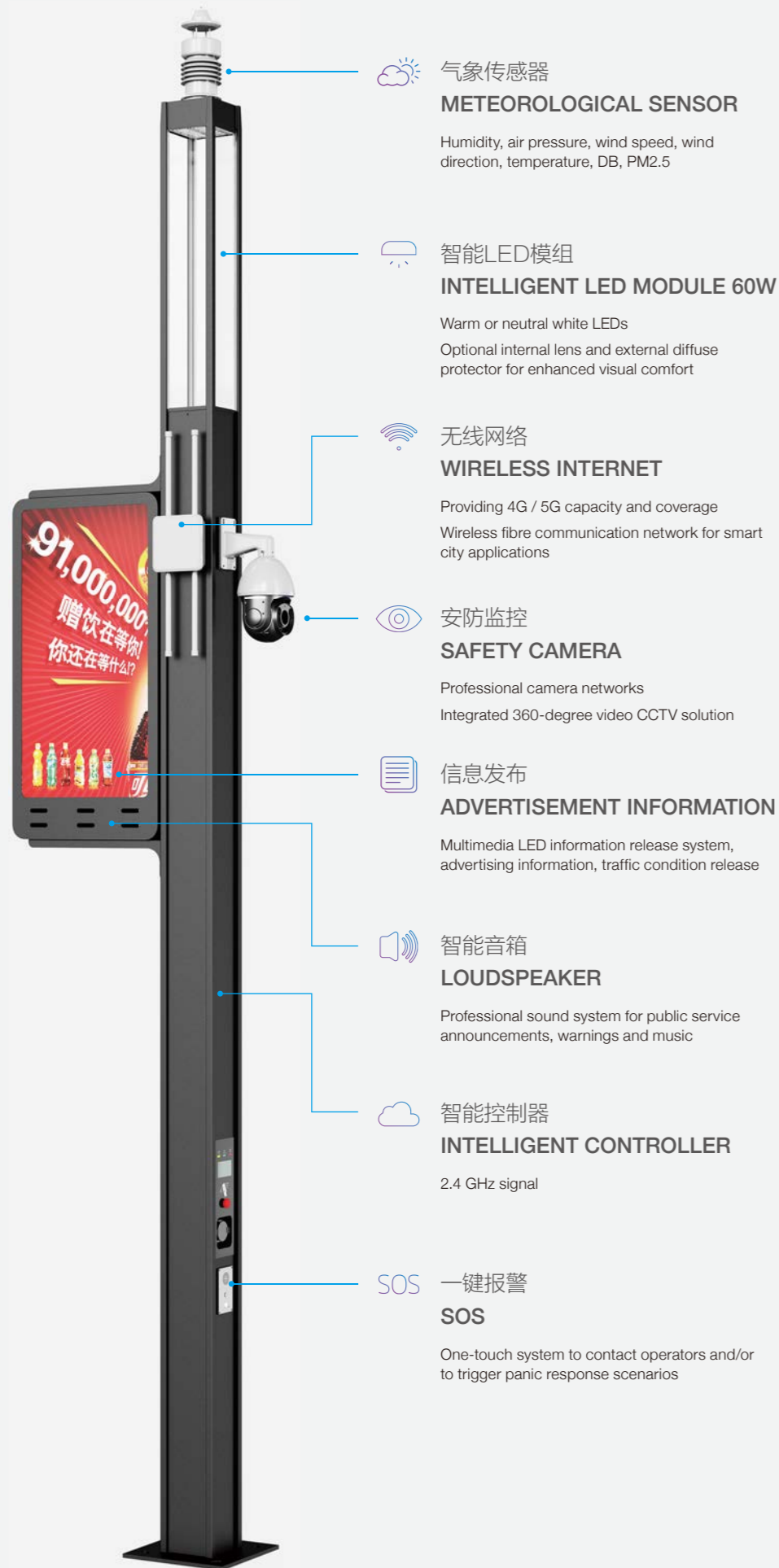



充电桩
EV CHARGING
 Professional charging station
 Safety locking during charging

简述 Description



- 铝压铸上盖和铝合金型材灯柱，根据需要切割成不同灯杆高度，PC透明塑料罩
- 灯具配光有2种形式，顶部SMD光源，具有很高视觉舒适性
- 驱动有0-10V / DALI / 编程电源选择，20KV浪涌保护器
- 模块式电器部件，安装更换方便
- 防紫外线聚氨酯塑粉喷涂表面，盐雾测试可以达1000小时以上
- 无生物蓝光危害风险，符合EN62471: 2008标准
- 道路灯智能远程控制系统可选，可以与远程管理系统兼容
- 所有外部螺钉均为304不锈钢材质

- Die-casting aluminium top cover, extruded aluminium column pole, the height according to the client required, PC transparent diffuser.
- There are two forms of light distribution: Asymmetric and symmetric optics, top SMD light source, it has good visual comfortable light effect.
- High quality LED chips, Driver with 0-10V/DALI/programmed options, and with surge protection up to 20KV.
- LED module is used inside, Integrated electrical components which is easy to install and replace.
- Surface anti-ultraviolet pure polyester powder painting, Corrosion resistance can be more than 1000 hours.
- No photo-biological risk, (no risk linked to infrared, blue light and UV radiation) in accordance with EN 62471:2008.
- Street lighting control used with smart control technology. It can be compatible with remote management system.
- All external screws are made of 304 stainless steel.

应用透镜 Optics application

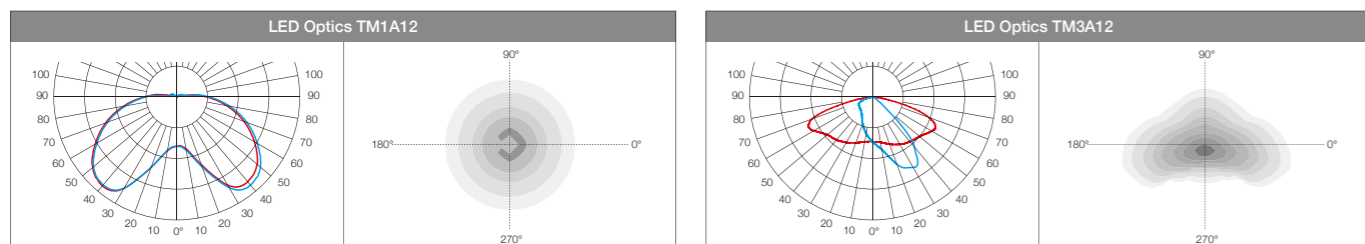

技术参数 Technology data



T-221

Code	Power	LED Qty	Optics	Weight	Pcs/20"	Pcs/40"
LED chips - 5050						
T-221LED60-24H400	60W	24	TM1A24/TM3A24	57	95	213
T-221LED60-24H500	60W	24	TM1A24/TM3A24	66	91	189



T-221SM

Code	Power	LED Qty	Optics	Weight	Pcs/20"	Pcs/40"
LED chips - 5050						
T-221SMLED60-24H400	60W	24	TM1A24/TM3A24	77	80	180
T-221SMLED60-24H500	60W	24	TM1A24/TM3A24	88	70	160
T-221SMLED60-24H600	60W	24	TM1A24/TM3A24	99	60	140

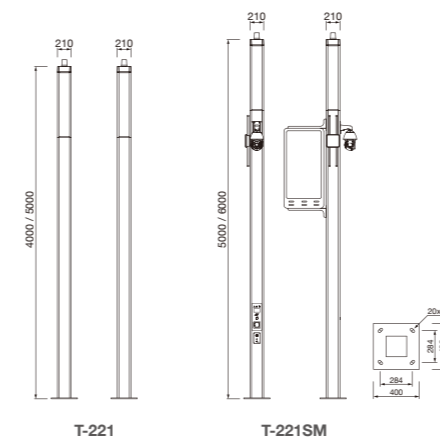

延伸产品 More in family

SOLAR OPTIONS



TS-221
Solar Lighting: 18W.

可选配件 Accessories options

	Code
接线盒 Junction Box	230000199
基础螺杆 Anchor Bolts	250000293





T-219 Series

Exclusivity in UK, Spain, Italy and Middle East counties



T-219AL
240-360W



T-219HM
150-240W



T-219PM
150-240W



一组融入现代设计元素的创意LED庭院灯具，有三种安装方式，分别功率从150W-360W，可适用于广场、机场、停车场等场合，符合多种功能照明需求，多种光学系统可选配。

A group of creative led courtyard lamps with modern design elements, which can be installed in three ways, The power is 150W-360W respectively, which can be applied to squares, airports, parking lots and other occasions, Meet the requirements of multi-functional lighting, and a variety of optical systems can be options.

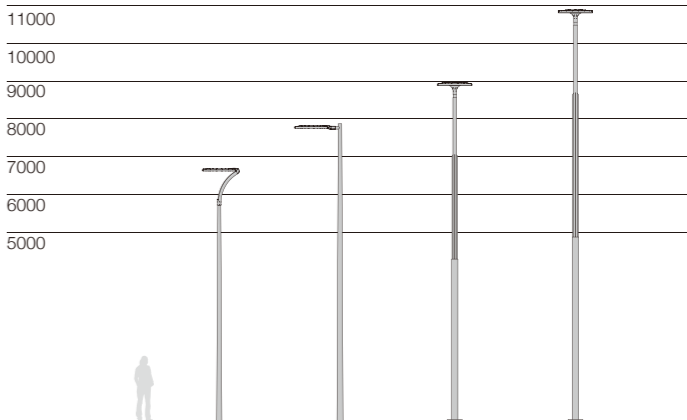

T-219 Series

Exclusivity in UK, Spain, Italy and Middle East counties



简述 Description



- 铝压铸灯体外壳，透明PC板
- 高透光PC透镜，具有高视觉舒适性和均匀配光透镜，供多种不同配光选择
- 高性能LED芯片，驱动有0-10V / DALI / 编程电源选择，20KV浪涌保护器
- 按钮式开启配置，维修更换方便
- 有3种安装方式，安装管径有 $\varnothing 60 / \varnothing 76\text{mm}$
- 防紫外线聚氨酯粉末喷涂表面，盐雾测试可以达1000小时以上
- 无生物蓝光危害风险，符合EN62471: 2008标准
- 道路灯智能远程控制系统可选，可以与远程管理系统兼容
- 所有外部螺钉均为304不锈钢材质

- Die-casting aluminium body, super white tempered glass.
- Optics with PC lens with high visual comfortable and uniform lighting distribution, multiple light distribution options.
- High quality LED chips, Driver with 0-10V/DALI/programmed be options, and with surge protection up to 20KV.
- Tool-free replaceable with push-button for opened device. The body can be detached and replaced easily.
- There are three installation modes, installation tube diameter $\varnothing 60/\varnothing 76\text{mm}$.
- Surface anti-ultraviolet pure polyester powder painting, Corrosion resistance can be more than 1000 hours.
- No photo-biological risk, (no risk linked to infrared, blue light and UV radiation) in accordance with EN 62471:2008.
- Street lighting control used with smart control technology. It can be compatible with remote management system.
- All external screws are made of 304 stainless steel.

应用透镜 Optics application

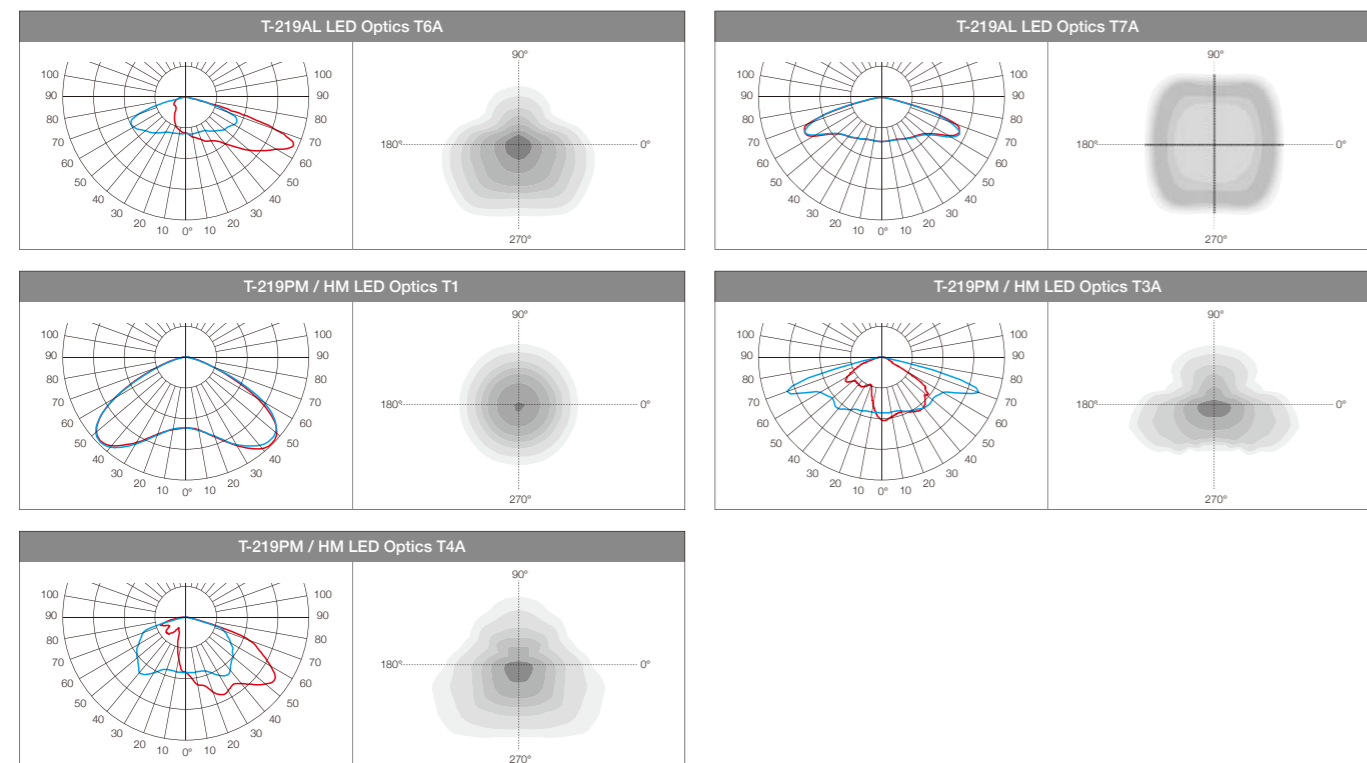

技术参数 Technology data

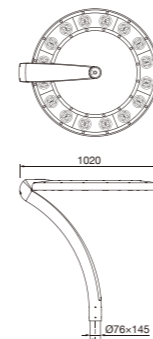
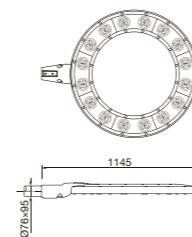
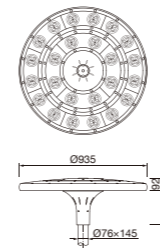

T-219AL

Code	Power	LED Qty	Optics	Packing Size	Weight	Pcs/20"	Pcs/40"
LED chips - 5050				Body:			
T-219ALLED240-96	240W	96	T6A/T7A	1010*1010*120	32	140	308
T-219ALLED330-96	330W	96	T6A/T7A	1010*1010*120	32.5	140	308
T-219ALLED360-96	360W	96	T6A/T7A	1010*1010*120	32.5	140	308
				Bracket: 640*640*285/4pcs			

T-219HM

Code	Power	LED Qty	Optics	Packing Size	Weight	Pcs/20"	Pcs/40"
LED chips - 5050				Body:			
T-219HMLED150-64	150W	64	T1/T3A/T4A	1010*1010*120	15	170	380
T-219HMLED200-64	200W	64	T1/T3A/T4A	1010*1010*120	15.5	170	380
T-219HMLED240-64	240W	64	T1/T3A/T4A	1010*1010*120	15.5	170	380

T-219PM

Code	Power	LED Qty	Optics	Packing Size	Weight	Pcs/20"	Pcs/40"
LED chips - 5050				Body:			
T-219PMLED150-64	150W	64	T1/T3A/T4A	1010*1010*120	26	154	318
T-219PMLED200-64	200W	64	T1/T3A/T4A	1010*1010*120	26.5	154	318
T-219PMLED240-64	240W	64	T1/T3A/T4A	1010*1010*120	26.5	154	318
				Bracket: 1310*235*155			

可选配件 Accessories options

	Code
	防水连接器 IP68 Connector 320000047
	$\varnothing 76$ -60转换套 Adapter 210001154 Adapter required for install on the pole.



T-232 Series



T-232RS
40-60W

T-232RM
75-120W

T-232M
75-120W

T-232W
40-75W

T-232S
40-60W

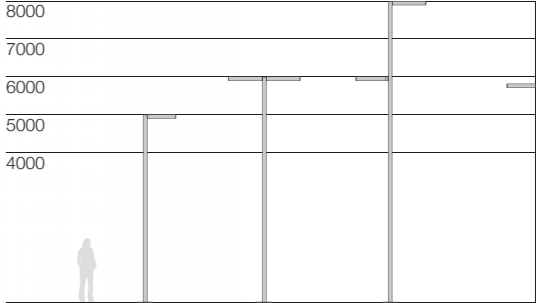

简述 Description



- 铝压铸灯体外壳，超白钢化玻璃，白色PC反射罩
- 高透光PC透镜，具有高视觉舒适性和均匀配光透镜，供多种不同配光选择
- 高性能LED芯片，驱动有0-10V / DALI / 编程电源选择，20KV浪涌保护器
- 灯具采用LED模组，安装更换方便
- 防紫外线聚氨酯粉末喷涂表面，盐雾测试可以达1000小时以上
- 无生物蓝光危害风险，符合EN62471: 2008标准
- 道路灯智能远程控制系统可选，可以与远程管理系统兼容
- 所有外部螺钉均为304不锈钢材质



MD-06L LED Module

- Die-casting aluminium body, super white tempered glass, PC white plastic reflector.
- Optics with PC lens with high visual comfortable and uniform lighting distribution, multiple light distribution options.
- High quality LED chips, Driver with 0-10V/DALI/programmed options, and with surge protection up to 20KV.
- LED module is used inside, which is easy to install and replace.
- Surface anti-ultraviolet pure polyester powder painting, Corrosion resistance can be more than 1000 hours.
- No photo-biological risk, (no risk linked to infrared, blue light and UV radiation) in accordance with EN 62471:2008.
- Street lighting control used with smart control technology. It can be compatible with remote management system.
- All external screws are made of 304 stainless steel.

应用透镜 Optics application

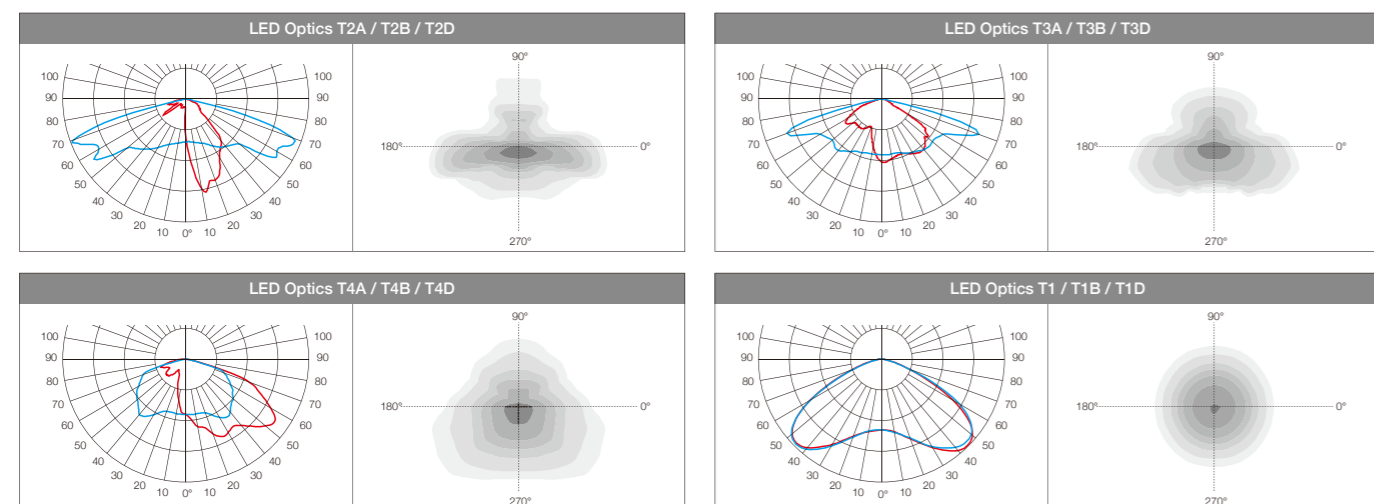

技术参数 Technology data

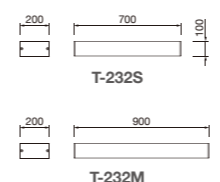

T-232S

Code	Power	LED Qty	Optics	Packing Size	Weight	Pcs/20"	Pcs/40"
LED chips - 3535/5050							
T-232SLED40-32	40W	32	T1/T2A/T3A/T4	740*240*140	6.3	1152	2352
T-232SLED60-32	60W	32	T1/T2A/T3A/T4	740*240*140	6.3	1152	2352

T-232M

Code	Power	LED Qty	Optics	Packing Size	Weight	Pcs/20"	Pcs/40"
LED chips - 3535/5050							
T-232MLED75-32	75W	32	T1/T2A/T3A/T4	940*240*140	7.5	764	1792
T-232MLED100-32	100W	32	T1/T2A/T3A/T4	940*240*140	7.5	764	1792
T-232MLED120-32	120W	32	T1/T2A/T3A/T4	940*240*140	7.5	764	1792

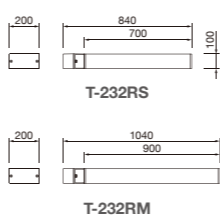

T-232RS

Code	Power	LED Qty	Optics	Packing Size	Weight	Pcs/20"	Pcs/40"
LED chips - 3535/5050							
T-232RSLED40-32	40W	32	T1/T2A/T3A/T4	740*240*140	7.3	1152	2352
T-232RSLED60-32	60W	32	T1/T2A/T3A/T4	740*240*140	7.3	1152	2352

T-232RM

Code	Power	LED Qty	Optics	Packing Size	Weight	Pcs/20"	Pcs/40"
LED chips - 3535/5050							
T-232RMLED75-32	75W	32	T1/T2A/T3A/T4	940*240*140	8.5	764	1792
T-232RMLED100-32	100W	32	T1/T2A/T3A/T4	940*240*140	8.5	764	1792
T-232RMLED120-32	120W	32	T1/T2A/T3A/T4	940*240*140	8.5	764	1792



T-232W

Code	Power	LED Qty	Optics	Packing Size	Weight	Pcs/20"	Pcs/40"
LED chips - 3535/5050							
T-232WLED40-32	40W	32	T1/T2A/T3A/T4	740*250*250	9.5	1152	2352
T-232WLED60-32	60W	32	T1/T2A/T3A/T4	740*250*250	9.5	1152	2352
T-232WLED75-32	75W	32	T1/T2A/T3A/T4	740*250*250	9.5	1152	2352

可选配件 Accessories options

	Code
灯杆封盖 Pole Cover	210004822
圆杆抱箍组件 Round Pole Hoop	220003043
壁装法兰 Wall Mounted Flange	220003051

MD-02N

材料: 铝压铸灯体, PP镀铬塑料反射罩
表面处理: 防紫外线静电喷涂

Material: Die-casting aluminum body,
PP reflector by chrome.
Finishing: Surface anti-ageing
electrostatic spray processing, super
resistance to corrosion.

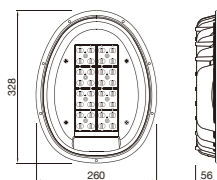

Code	Power	LED Qty	Optics	Packing Size	Weight	Pcs/20"	Pcs/40"
LED chips - 3535/5050							
MD-02NLED40-16	40W	16	T2A/T3A/T4A/T2W/T4	570*360*210/4pcs	10.6/4pcs	2560	5200
MD-02NLED60-24	60W	24	T2D/T3D/T4D	570*360*210/4pcs	10.6/4pcs	2560	5200
MD-02NLED75-32	75W	32	T2A/T3A/T4A/T2W/T4	570*360*210/4pcs	10.6/4pcs	2560	5200
MD-02NLED100-48	100W	48	T2D/T3D/T4D	570*360*210/4pcs	10.6/4pcs	2560	5200
LED chips - 3030							
MD-02NLED60-56	60W	56	T1B/T2B/T3B/T4B	570*360*210/4pcs	10.6/4pcs	2560	5200
MD-02NLED100-112	100W	112	T1B/T2B/T3B/T4B	570*360*210/4pcs	10.6/4pcs	2560	5200

MD-04

材料: 铝压铸灯体, PP镀铬塑料反射罩
表面处理: 防紫外线静电喷涂

Material: Die-casting aluminum body,
PP reflector by chrome.
Finishing: Surface anti-ageing
electrostatic spray processing, super
resistance to corrosion.

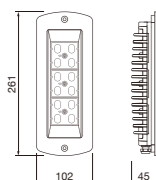

Code	Power	LED Qty	Optics	Packing Size	Weight	Pcs/20"	Pcs/40"
LED chips - 3535/5050							
MD-04LED30-12	30W	12	T2A/T3A/T4A/T2W/T4	290*255*235/6pcs	7.5/6pcs	9180	19224
MD-04LED40-18	40W	18	T2D/T3D/T4D	290*255*235/6pcs	7.5/6pcs	9180	19224
MD-04LED60-18	60W	18	T2D/T3D/T4D	290*255*235/6pcs	7.5/6pcs	9180	19224

MD-06

材料: 铝压铸灯体, PP镀铬塑料反射罩
表面处理: 防紫外线静电喷涂

Material: Die-casting aluminum body,
PP reflector by chrome.
Finishing: Surface anti-ageing
electrostatic spray processing, super
resistance to corrosion.

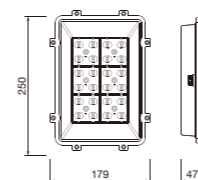
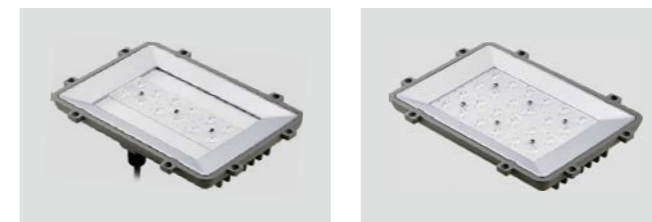

Code	Power	LED Qty	Optics	Packing Size	Weight	Pcs/20"	Pcs/40"
LED chips - 3535/5050							
MD-06LED30-12	30W	16	T1/T2A/T3A/T4A	550*400*200/8pcs	10.0/8pcs	5016	10296
MD-06LED40-24	40W	24	T1/T2A/T3A/T4A	550*400*200/8pcs	10.0/8pcs	5016	10296
MD-06LED60-24	60W	24	T1/T2A/T3A/T4A	550*400*200/8pcs	10.0/8pcs	5016	10296
MD-06LED75-36	75W	36	T1D/T2D/T3D/T4D	550*400*200/8pcs	10.0/8pcs	5016	10296
LED chips - 3030							
MD-06LED40-56	40W	56	T1B/T2B/T3B/T4B	550*400*200/8pcs	10.0/8pcs	5016	10296
MD-06LED60-84	60W	84	T1B/T2B/T3B/T4B	550*400*200/8pcs	10.0/8pcs	5016	10296

MD-06A

材料: 铝压铸灯体, PP镀铬塑料反射罩
表面处理: 防紫外线静电喷涂

Material: Die-casting aluminum body,
PP reflector by chrome.
Finishing: Surface anti-ageing
electrostatic spray processing, super
resistance to corrosion.

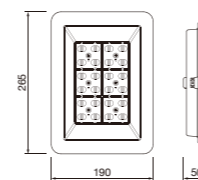

Code	Power	LED Qty	Optics	Packing Size	Weight	Pcs/20"	Pcs/40"
LED chips - 3535/5050							
MD-06ALED30-12	30W	12	T1/T2A/T3A/T4A	570*420*200/8pcs	12.2/8pcs	4752	9856
MD-06ALED40-24	40W	24	T1/T2A/T3A/T4A	570*420*200/8pcs	12.2/8pcs	4752	9856
MD-06ALED60-24	60W	24	T1/T2A/T3A/T4A	570*420*200/8pcs	12.2/8pcs	4752	9856
MD-06ALED75-36	75W	36	T1D/T2D/T3D/T4D	570*420*200/8pcs	12.2/8pcs	4752	9856
LED chips - 3030							
MD-06ALED40-56	40W	56	T1B/T2B/T3B/T4B	570*420*200/8pcs	12.2/8pcs	4752	9856
MD-06ALED60-84	60W	84	T1B/T2B/T3B/T4B	570*420*200/8pcs	12.2/8pcs	4752	9856

MD-06L

材料: 铝压铸灯体, 白色PC塑料反射罩
表面处理: 防紫外线静电喷涂

Material: Die-casting aluminum body, PC white plastic reflector.
Finishing: Surface anti-ageing electrostatic spray processing, super resistance to corrosion.

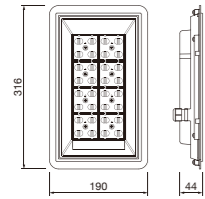

Code	Power	LED Qty	Optics	Packing Size	Weight	Pcs/20"	Pcs/40"
LED chips - 3535/5050							
MD-06LLED60-32	A3 60W	32	T1/T2/T3A/T4A	420*345*260/6pcs	12.0/6pcs	4128	8640
MD-06LLED75-32	A3 75W	32	T1/T2/T3A/T4A	420*345*260/6pcs	12.0/6pcs	4128	8640
MD-06LLED100-32	A3 100W	32	T1/T2/T3A/T4A	420*345*260/6pcs	12.0/6pcs	4128	8640
MD-06LLED120-48	D3 120W	48	T1D/T2D/T3D/T4D	420*345*260/6pcs	12.0/6pcs	4128	8640

MD-07

材料: 铝挤压氧化散热块
表面处理: 表面氧化处理

Material: Extruded aluminum heatsink.
Finishing: Surface by oxy. finishing.

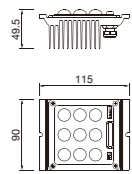

Code	Power	LED Qty	Optics	Packing Size	Weight	Pcs/20"	Pcs/40"
LED chips - 3535/5050							
MD-07LED20-9	20W	9	T19	370*370*210/36pcs	15.5/36pcs	32400	69120
LED chips - 3030							
MD-07LED10-9	10W	9	T19	370*370*210/36pcs	15.5/36pcs	32400	69120

MD-08

材料: 铝挤压氧化散热块
表面处理: 表面氧化处理

Material: Extruded aluminum heatsink.
Finishing: Surface by oxy. finishing.

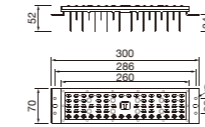
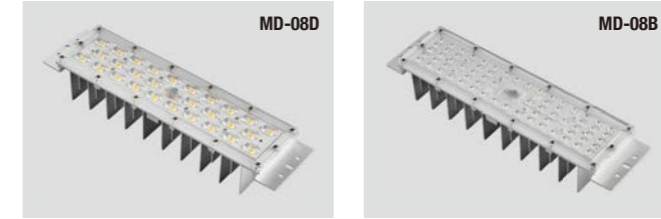

Code	Power	LED Qty	Optics	Packing Size	Weight	Pcs/20"	Pcs/40"
LED chips - 5050							
MD-08DLED60-28	60W	28	TM1/TM2/TM3/TM4	345*245*200/12pcs	6.5/12pcs	20196	41448
LED chips - 3030							
MD-08BLED60-66	60W	66	TM2B	345*245*200/12pcs	6.5/12pcs	20196	41448

