

宁波金羽桥照明科技有限公司
NINGBO KING-BRIDGE LIGHTING
TECHNOLOGY CO.,LTD.

地址：浙江省余姚市阳明街道新桥工业区
Add: Xinqiao Industry Zone, Yangming Street, Yuyao City,
Zhejiang Province, China
Tel: +86-574-6256 6890
Fax: +86-574-6256 6827
info@kled.com

国内营销中心:

金羽桥照明科技（上海）有限公司
地址：上海市长宁区中山西路179号4K室
电话：189 1897 7928

KLED
— King-Bridge Lighting —

Flood Lighting
Tunnel Lighting
Highbay Lighting



KLED.com



Flood / Tunnel / Highbay Lighting

Lighting effects for illuminating architecture. Broad range of lighting effects: from highly concentrated beams of light to lighting of architectural details, wall washer light beams for uniform lighting of facades and vertical surfaces.

Flood Lighting

P6	TG-201
P14	TG-221
P22	TG-231
P24	TG-163
P34	TG-161
P44	TG-202
P52	TG-162
P56	TG-120
P60	TG-215
P66	TG-213
P70	TG-211
P76	TG-13
P80	TG-12

Tunnel Lighting

P84	S-120
-----	-------

Highbay Lighting

P88	F-202
P92	F-03



Power	480-720W	600-1500W	600-1500W	400-1800W	40-480W	75-240W	100-200W	25-75W	15-75W	35-75W	25-100W
Light flux LM	70000→105000	93000→233000	93000→233000	58000→260000	5800→69000	10000→33500	14000→28000	3500→10500	2350→9800	4500→9750	3250→13000
Colour temperature K	3000 / 4000 / 5000	4000 / 5000 / 5700	4000 / 5000 / 5700	4000 / 5000 / 5700	3000 / 4000 / 5000	3000 / 4000 / 5000	3000 / 4000 / 5000	3000 / 4000 / 5000	3000 / 4000 / 5000	3000 / 4000 / 5000	3000 / 4000 / 5000
RGBW	-	●	●	●	●	●	●	-	●	●	●
DALI	●	●	●	●	●	●	●	●	●	●	●
DMX	-	●	●	●	●	●	●	-	●	●	●
Number of size	1	3	3	3	4	2	1	2	3	2	2
Spike	-	-	-	-	-	-	-	●	●	-	●



Power	15-25W	9-25W	60-180W	75-240W	60-240W
Light flux LM	1800→3000	1080→3000	8700→26000	10500→33600	8700→35000
Colour temperature K	3000 / 4000 / 5000	3000 / 4000 / 5000	3000 / 4000 / 5000	3000 / 4000 / 5000	3000 / 4000 / 5000
RGBW	●	●	-	-	-
DALI	-	-	●	●	●
DMX	●	●	-	-	-
Number of size	2	2	2	2	2
Wireless controls	●	●	●	●	●





TG-201
High mast luminaire



480-720W



TG-201

一款全新设计用于新的和改造工程的高杆应用灯具，采用最新的高效LED技术，它为最简单到最复杂的区域照明应用提供了完整的照明解决方案。经过特殊设计的光学模块和全方位的光分布选项，以满足最高性能标准，并提供卓越的光学可视性和一致性。

A new design luminaire for new and modified high pole applications, using the latest high efficiency LED technology, provides a complete lighting solution for the simplest to most complex area lighting applications. Specially designed optical modules have a full range of light distribution options to meet the highest performance standards and provide superior visibility and consistency.

A NEW HIGH POWER HIGH MAST LUMINAIRE



独立电器箱设计，插拔式电器连接，IP66防护等级

Independent electrical box design, plug-in electrical connection, IP66 protection level.



通过特殊固定盘设计，可实现LED模组在水平方向-165°~+180°旋转

Through the special fixed disk design, the LED module can rotate at -165° ~ +180° in the horizontal circumferential direction.



IK09钢化玻璃罩，模组式透镜供多种不同光型可选，以满足不同路面的照明需求

IK09 tempered glass, Modular lens is available for various light types to meet the lighting requirements of different roads.



独特背部设计，有利灯具可靠散热。另可配智能控制系统，以实现远程智调控

Unique back design, good for reliable heat dissipation. it can be with intelligent control system to realize remote intelligent control.



通过四颗螺栓固定，适用于Ø42~Ø60mm安装管径固定，灯具角度-5°~+5°可调

Four bolt mounting suitable for Ø42mm to Ø60mm side entry, -5° ~ +5° angle adjustable.

简述 Description

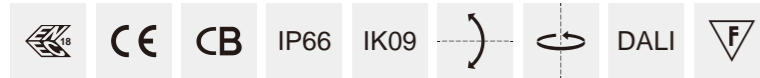

- 灯具外壳采用铝合金压铸而成，灯具电器箱和光源模组采用分离式独立结构
- 高透光PC透镜，具有高视觉舒适性和均匀配光透镜，供多种不同配光选择
- 高性能LED芯片，驱动有0-10V / DALI / 编程电源选择，20KV浪涌保护器
- 电器箱采用独特铁扣设计，安全快捷开启，整体防护IP66
- 侧装安装方式，角度可调，安装管径有Ø42-Ø60mm
- 防紫外线聚氨酯粉末喷涂表面，盐雾测试可以达1000小时以上
- 无生物蓝光危害风险，符合EN62471: 2008标准
- 道路灯智能远程控制系统可选，可以与远程管理系统兼容
- 所有外部螺钉均为304不锈钢材质

- Die-casting aluminum alloy housing, the electrical box and light module adopt separate independent structure.
- Optics with PC lens with high visual comfortable and uniform lighting distribution, multiple light distribution options.
- High quality LED chips, Driver with 0-10V/DALI/programmed be options, and with surge protection up to 20KV.
- The electrical box adopts unique lock design, safe and fast opening, and the overall protection is IP66.
- Top and side fixing, angle can be adjustable, installation tube diameter Ø42~Ø60mm.
- Surface anti-ultraviolet pure polyester powder painting, Corrosion resistance can be more than 1000 hours.
- No photo-biological risk, (no risk linked to infrared, blue light and UV radiation) in accordance with EN 62471:2008.
- Street lighting control used with smart control technology. It can be compatible with remote management system.
- All external screws are made of 304 stainless steel.

• 应用场合: 货运站、停车场、港口、码头机场、高速公路和广场等大面积场所

• Applications: Freight Terminals, Car Parks, Ports and docks, Airports, Motorways, Toll Plazas and Others large place.

应用透镜 Optics application

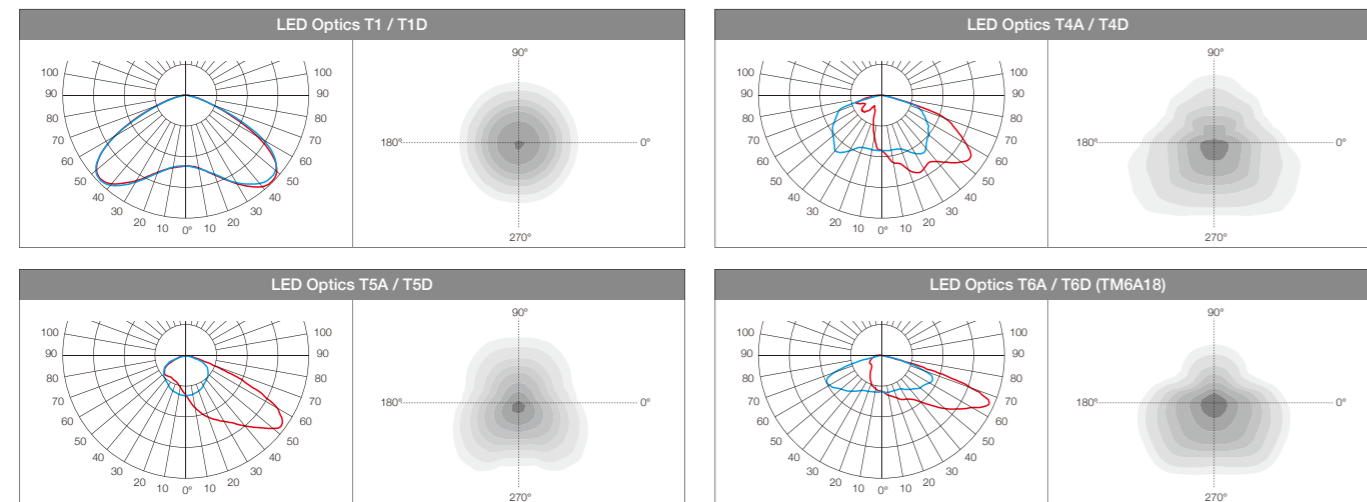

技术参数 Technology data

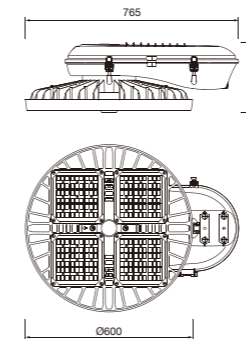

TG-201

Code	Power	LED Qty	Optics	Packing Size	Weight	Pcs/20"	Pcs/40"
LED chips - 3535/5050							
TG-201LED480-144	480W	144	T1A/T4A/T5A/T6A	690*690*300	26.0	168	357
TG-201LED600-216	600W	216	T1D/T4D/T5D/T6D	690*690*300	26.0	168	357
TG-201LED660-216	660W	216	T1D/T4D/T5D/T6D	690*690*300	26.0	168	357
TG-201LED720-216	720W	216	T1D/T4D/T5D/T6D	690*690*300	26.0	168	357

Aerodynamic resistance (CxS): 0.28 m²

延伸产品 More in family



TG-201F
For Flood Lighting: 480-660W.



F-201
For High Bay Lighting: 320-480W.

TG-221 Series
A High Power LED Flood Lighting



TG-221-3M
600-720W



TG-221-4M
800-1000W



TG-221-6M
1200-1500W



TG-221 Series

一款模块化并具有电视转播一致性指数 (TLCI) 的LED体育场照明灯具, 并提供多种光学系统, 能满足各类体育场地的照明需求。

A LED stadium lighting fixture with TLCI (Television Lighting Consistency Index) that surpasses similar products and provides a variety of optical systems to meet the lighting needs of various stadiums.



简述 Description

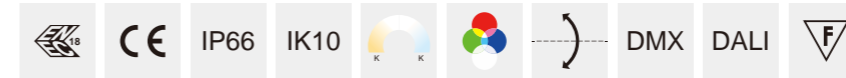

- 灯具散热器采用6063型材, 灯具电器箱和光源模组采用分离式独立结构
- 高效透镜光学设计, 具有高视觉舒适性和均匀配光透镜, 供多种不同配光选择
- 电器箱采用独特设计, 安全快捷开启, 整体防护IP66
- 防紫外线聚氨酯喷涂表面, 盐雾测试可以达1000小时以上
- 无生物蓝光危害风险, 符合EN62471: 2008标准
- 所有外部螺钉均为304不锈钢材质

- The lighting radiator adopts 6063 profile, the electrical box and light adopt separate independent structure.
- Optics with lens design with high visual comfortable and uniform lighting distribution, multiple light distribution options.
- The electrical box adopts unique design, safe and fast opening, and the overall protection is IP66.
- Surface anti-ultraviolet pure polyester powder painting, Corrosion resistance can be more than 1000 hours.
- No photo-biological risk, (no risk linked to infrared, blue light and UV radiation) in accordance with EN 62471:2008.
- All external screws are made of 304 stainless steel.

- 抗振等级: 通过5G / 15Hz / 3轴各10万次振动测试
- 风压测试: >65m/s
- 功率: 600W-1500W
- 光效: 150-170 Lm/W
- 色温: 4000K / 5000K / 5700K
- 显色指数: >70Ra / 80Ra / 90Ra
- 功能选项: 0-10V / DALI / DMX / RGBW

- Anti vibration grade: Passed 100K times vibration tests of 5G / 15Hz / 3 axis.
- Wind pressure test: >65m/s
- Power: 600W-1500W
- Nominal efficacy: 150-170 Lm/W
- CCT: 4000K / 5000K / 5700K
- CRI: >70Ra / 80Ra / 90Ra
- Options: 0-10V / DALI / DMX / RGBW

- 应用场合: 体育馆、港口码头、机场及大型建筑立面泛光照明

- Applications: Sport stadium, port, and larger building illumination.

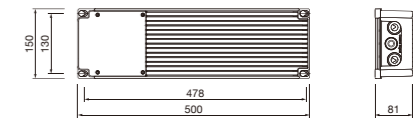

智能一体式驱动 Intelligent driver

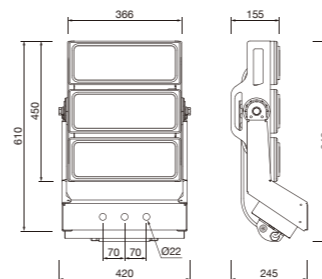

TG-221-3M

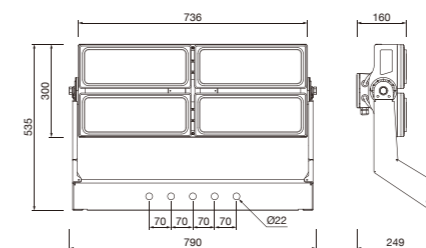

TG-221-4M

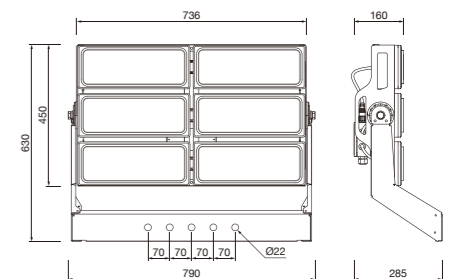

TG-221-6M

不对称透镜 Asymmetric optics

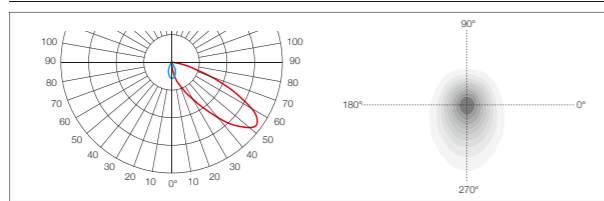

TMA166
适用于运动场、广场、十字路口、停车场等区域照明
Asymmetrical Optic
For sports ground, square, intersection, parking and other areas.

LED Chips: 66 in 1

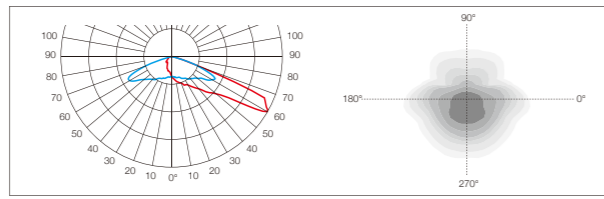

TM6A66
适用于运动场、广场、十字路口、停车场等区域照明
Asymmetrical Optic
For sports ground, square, intersection, parking and other areas.

LED Chips: 66 in 1

对称透镜 Symmetric optics

Narrow

TM08A66

α 8°

TM25A66

α 15°

SAMSUNG 351C

Middle / Wide

TM25A66

α 25°

TM50A66

α 50°

TM90A66

α 90°

LUMILEDS 5050

灯具颜色 Colour optics

灯珠颜色的变化可以提供丰富多彩的动画RGBW效果。可以点亮屋顶，突出立面，甚至创建定制的颜色图案的屋顶照明。观众将能够体验一个独特精彩的体育活动。

The change of lamp bead color can provide rich and colorful animation RGBW effects. it can light the roof, highlight the facade, and even create custom color pattern roof lighting. The audience will be able to enough to experience a unique and wonderful sports activity.

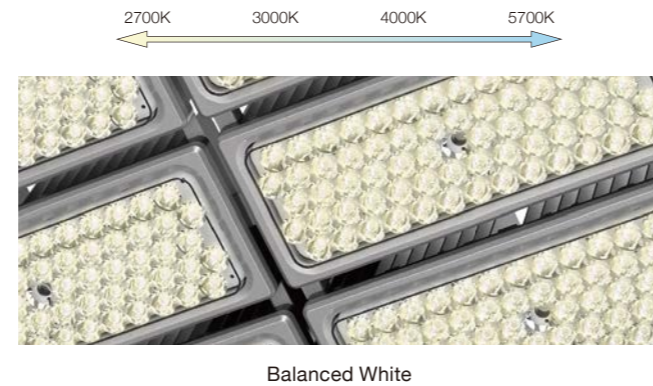
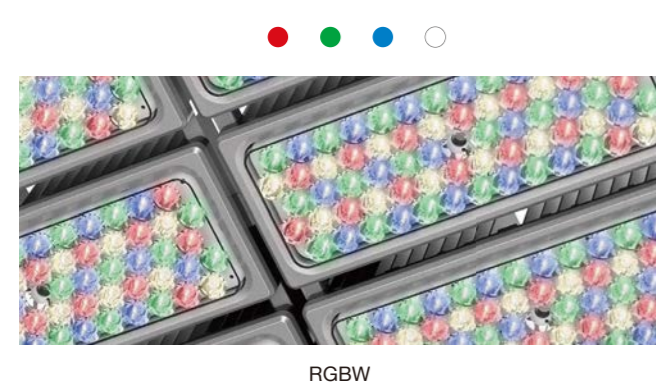

技术参数 Technology data



TG-221-3M

Code	Power	LED Qty	Packing Size	Weight	Pcs/20"	Pcs/40"
LED chips - 3535/5050						
TG-221LED600-3M	600W	198	650*435*295	17.5	301	630
TG-221LED720-3M	720W	198	650*435*295	18.0	301	630



TG-221-4M

Code	Power	LED Qty	Packing Size	Weight	Pcs/20"	Pcs/40"
LED chips - 3535/5050						
TG-221LED800-4M	800W	264	805*575*200	16.5	234	484
TG-221LED1000-4M	1000W	264	805*575*200	16.5	234	484

Remark:
Intelligent integrated driver:
Weight / Packing: 5.5kg / 590*250*165



TG-221-6M

Code	Power	LED Qty	Packing Size	Weight	Pcs/20"	Pcs/40"
LED chips - 3535/5050						
TG-221LED1200-6M	1200W	396	805*685*215	21	188	388
TG-221LED1500-6M	1500W	396	805*685*215	21	188	388

Remark:
Intelligent integrated driver:
Weight / Packing: 5.5kg / 590*250*165

延伸产品 More in family



TG-221A-3M



TG-221A-4M



TG-221A-6M

可选配件 Accessories options

	Code
防眩罩(3M) Visor (3M)	220002832
防眩罩(4M) Visor (4M)	220002833
防眩罩(6M) Visor (6M)	220002834

灯具系列 Product series



三模组
3 Modules



四模组
4 Modules



六模组
6 Modules

专业驱动 Professional driver

智能一体式驱动
Intelligent integrated driver

无论是大型体育场、娱乐场还是区域性照明，紧凑型专业驱动在所有类型的安装中都能提供便捷和卓越的性能。

Whether large stadiums, casinos or area illumination compact special lighting driver can provide high performance and more convenient in all of installations.

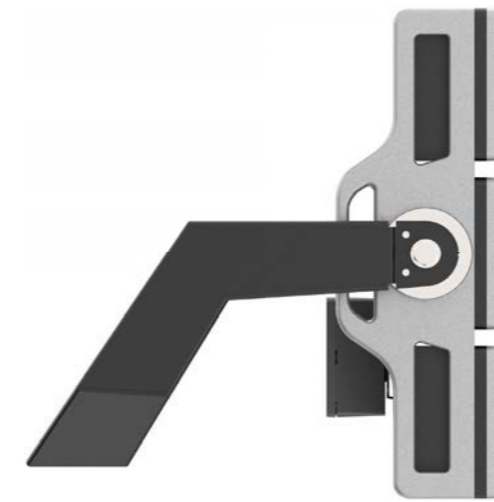

灵活直观的设计
Flexible and intuitive design

此款灯具配有手把，提拿安装更方便。角度调整使用刻度盘很简单，可以快速精确地对准，满足多种照明需求，使用更加得心应手。

This luminaire is equipped with handle, which is more convenient to carry and install. The measuring disk is very simple to use and can rapid and accurate alignment can meet a variety of lighting needs and make it easier to use.

精准光学组件 + 精准瞄准器
Multiple optical options
+ Aiming sight

灯具具有多种光学透镜选项，安装时通过瞄准器精准控制光的投射位置。

The luminaire has multiple optical options, When installing the luminaire, it can accurately adjust the projection angle through the aiming sight advice .

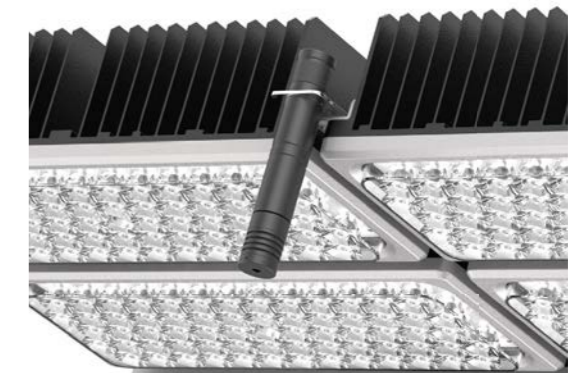

模组化设计 + 快速插拔接头
Modular design
+ Quick-Plug connector

此款灯具采用模组化设计，降低了维护成本，模组之间设有增强空气对流的通道，可以加强灯具散热、降低热量聚集。灯具背部采用快速插拔电缆连接设计，满足客户快捷安装维护要求。

The modular design of this lamp reduces the maintenance cost. There is a channel to enhance air convection between the modules, which means that the heat dissipation of the luminaire can be strengthened and the heat accumulation can be reduced. quick-plug cable connected design, it can meet the customers for quickly installation and maintenance requirements.



TG-231 Series

Extended products from TG-221

为适应不同客户需求，该产品依托TG-221灯具为原型而做出的拓展款灯型：

- TG-221侧重于对灯具安装高度尺寸有限定要求用户，而TG-231侧重于对灯具宽度尺寸有限定要求用户。
- TG-231灯具其单个模组角度可以独立调节，TG-221灯具只能整体灯具角度可调。

In order to meet the requirements of different customers, this product is based on the expanded product from TG-221:

- TG-221 focuses on the requirements for limited the height size; but TG-231 focuses the requirements for the width size.
- TG-231 the single module angle can be adjustable, but TG-221 can only adjust the angle of the whole lighting.



TG-231-6M
1200-1500W



TG-231-3M
600-720W



TG-231-4M
800-1000W



技术参数 Technology data



TG-231-3M

Code	Power	LED Qty	Packing Size	Weight	Pcs/20"	Pcs/40"
LED chips - 3535/5050						
TG-231LED600-3M	600W	198	805*435*160	16	455	936
TG-231LED720-3M	720W	198	805*435*160	17	455	936



TG-231-4M

Code	Power	LED Qty	Packing Size	Weight	Pcs/20"	Pcs/40"
LED chips - 3535/5050						
TG-231LED800-4M	800W	264	805*435*160	15.5	334	692
TG-231LED1000-4M	1000W	264	805*435*160	15.5	334	692

Remark:
Intelligent integrated driver:
Weight / Packing: 6kg / 585*490*170/2Pcs



TG-231-6M

Code	Power	LED Qty	Packing Size	Weight	Pcs/20"	Pcs/40"
LED chips - 3535/5050						
TG-231LED1200-6M	1200W	396	805*640*135	20.4	292	606
TG-231LED1500-6M	1500W	396	805*640*135	20.4	292	606

Remark:
Intelligent integrated driver:
Weight / Packing: 6.5kg / 585*490*170/2Pcs

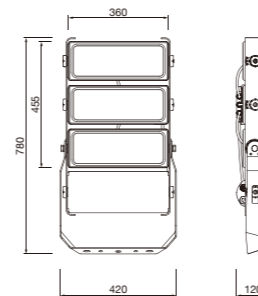

TG-231-3M

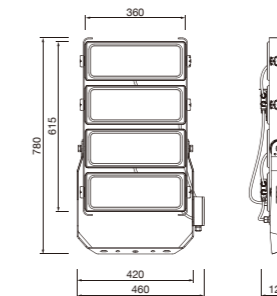

TG-231-4M

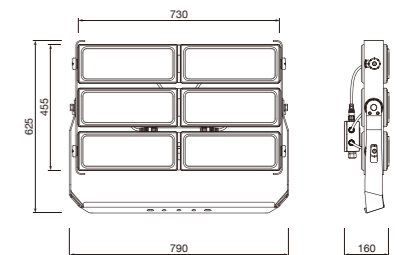

TG-231-6M

可选配件 Accessories options

	Code
	防眩罩(4M) Visor (4M) 220003402
	防眩罩(6M) Visor (6M) 220003403

TG-163 Series
A High Power LED Flood Lighting



TG-163S
400-600W



TG-163L
800-1200W



TG-163XL
1200-1800W





TG-163 Series

一款超越同类产品的具备电视转播一致性指数 (TLCI) 的LED体育场照明灯具, 并提供多种光学系统, 能满足各类体育场地的照明需求。

A LED stadium lighting fixture with TLCI (Television Lighting Consistency Index) that surpasses similar products and provides a variety of optical systems to meet the lighting needs of various stadiums.

3 SIZES



简述 Description

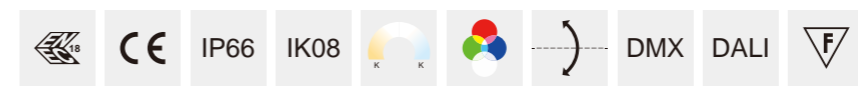

- 灯具外壳采用铝合金压铸而成, 灯具电器箱和光源模组采用分离式独立结构
- 高效反光杯光学设计, 具有高视觉舒适性和均匀配光透镜, 供多种不同配光选择
- 电器箱采用独特设计, 安全快捷开启, 整体防护IP66
- 防紫外线聚氨酯塑料喷涂表面, 盐雾测试可以达1000小时以上
- 无生物蓝光危害风险, 符合EN62471: 2008标准
- 所有外部螺钉均为304不锈钢材质

- Die-casting aluminum alloy housing, the electrical box and light module adopt separate independent structure.
- Optics with reflector design with high visual comfortable and uniform lighting distribution, multiple light distribution options.
- The electrical box adopts unique design, safe and fast opening, and the overall protection is IP66.
- Surface anti-ultraviolet pure polyester powder painting, Corrosion resistance can be more than 1000 hours.
- No photo-biological risk, (no risk linked to infrared, blue light and UV radiation) in accordance with EN 62471:2008.
- All external screws are made of 304 stainless steel.

抗振等级: 通过5G / 15Hz / 3轴各10万次振动测试
 风压测试: >65m/s
 功率: 400W-1800W
 光效: 110-135 Lm/W
 色温: 4000K / 5000K / 5700K
 显色指数: >80Ra / 90Ra
 功能选项: 0-10V / DALI / DMX / RGBW

Anti vibration grade: Passed 100K times vibration tests of 5G / 15Hz / 3 axis.
 Wind pressure test: >65m/s
 Power: 400W-1800W
 Nominal efficacy: 110-135 Lm/W
 CCT: 4000K / 5000K / 5700K
 CRI: >80Ra / 90Ra
 Options: 0-10V / DALI / DMX / RGBW

- 应用场合: 体育馆、港口码头、机场及大型建筑立面泛光照明
- Applications: Sport stadium, port, and larger building illumination.

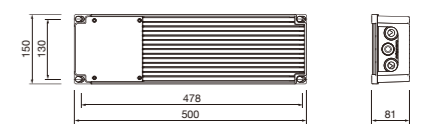

智能一体式驱动 Intelligent driver

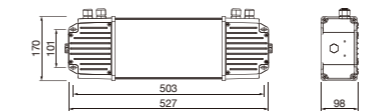

Q-04SAM

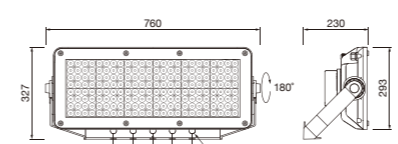

TG-163S

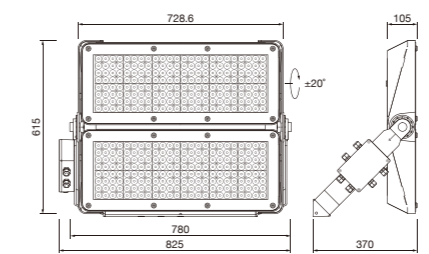

TG-163L

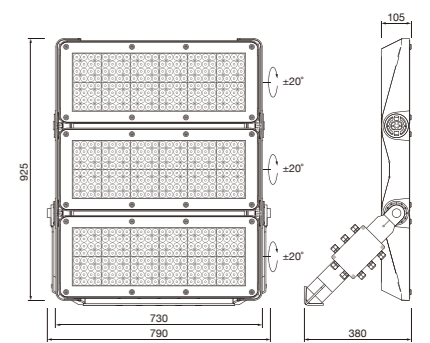

TG-163XL



特殊设计散热系统，能可靠保证灯具的光衰速率和寿命，并每个模组角度可调，角度调节范围±20度

The specially designed heat dissipation can reliably ensure the light maintenance and lifetime. The angle of each module is adjustable, and the angle adjustment range is ±20 degree.

智能一体式驱动
Intelligent integrated driver



DMX DALI

无论是大型体育场、娱乐场还是区域性照明，紧凑型专业驱动在所有类型的安装中都能提供便捷和卓越的性能

Whether large stadiums, casinos or area illumination compact special lighting driver can provide high performance and more convenient in all of installations.



灯具安装时通过瞄准器精准控制光的投射位置，角度调整完毕后装上安全绳，能防止灯具的意外跌落

When installing lamps and lanterns, the projection position of the light is precisely controlled by the aiming sight, and the safety rope is installed after the angle adjustment, which can prevent the lamps and lanterns from falling unexpectedly.



旋转固定螺钉，外加塑料防护盖，能方便调节灯具的投射角度

Complete with protractor scale for precise aiming of the floodlight.



不对称反光杯 Asymmetric reflector optics

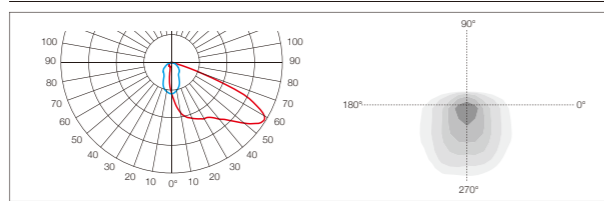

AH1
适用于运动场、广场、十字路口、停车场等区域照明
Asymmetrical Optic 40° * 70°
For sports ground, square, intersection, parking and other areas.

LED Chips: 4 in 1

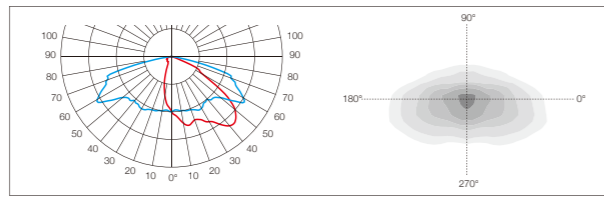

AH3
适用于运动场、广场、十字路口、停车场等区域照明
Asymmetrical Optic TYPE II
For sports ground, square, intersection, parking and other areas.

LED Chips: 4 in 1

单颗对称透镜 Beam lens optics

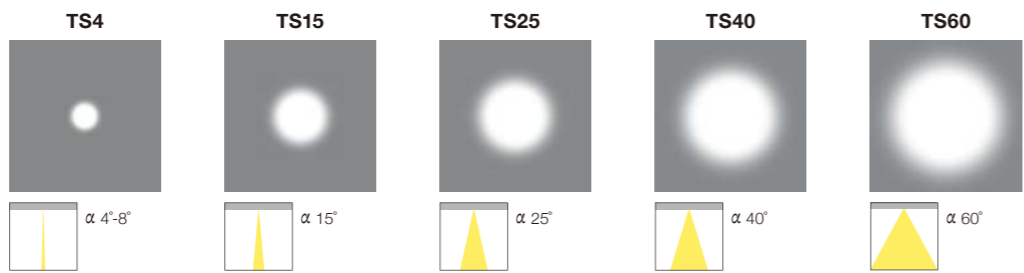

组合对称透镜 Symmetric lens optics

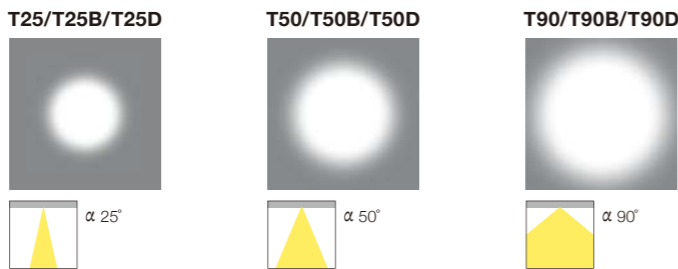

对称反光杯 Symmetric reflector optics

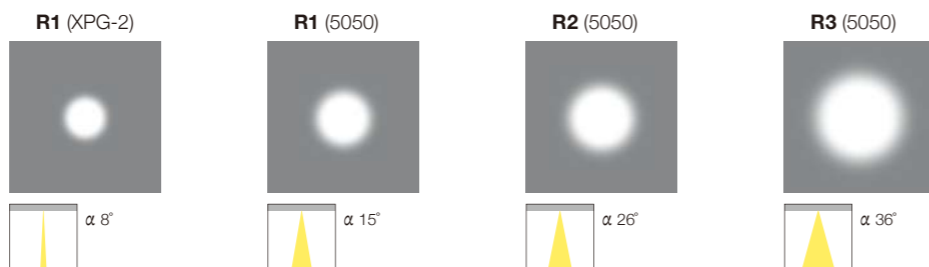
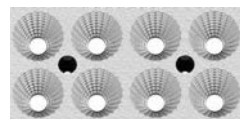

技术参数 Technology data



TG-163S

Code	Power	LED Qty	Optics	Packing Size	Weight	Pcs/20"	Pcs/40"
LED chips - 3535/5050							
TG-163SLED400-192	400W	192	R1/R2/R3/T50/T90	780*415*230	22	315	675
TG-163SLED480-192	480W	192	R1/R2/R3/T50/T90	780*415*230	22	315	675
TG-163SLED600-192	600W	192	R1/R2/R3/T50/T90	780*415*230	22	315	675
LED chips - XHP50							
TG-163SLED400-48	400W	48	AH1/AH3	780*415*230	22	315	675
TG-163SLED480-48	480W	48	AH1/AH3	780*415*230	22	315	675
LED chips - XML COLOUR							
TG-163SLED480-48RGBW	480W	48	TS25/TS40/TS60	780*415*230	22	315	675



TG-163L

Code	Power	LED Qty	Optics	Packing Size	Weight	Pcs/20"	Pcs/40"
LED chips - 3535/5050							
TG-163LLED800-384	800W	384	R1/R2/R3/T50/T90	Luminaire: 870*820*165 Body:	32	182	364
TG-163LLED1000-384	1000W	384	R1/R2/R3/T50/T90	870*820*165	32	182	364
TG-163LLED1200-384	1200W	384	R1/R2/R3/T50/T90	870*820*165	32	182	364
LED chips - XHP50							
TG-163LLED800-96	800W	96	AH1/AH3	870*820*165	32	182	364
TG-163LLED1000-96	1000W	96	AH1/AH3	870*820*165	32	182	364
LED chips - XML COLOUR							
TG-163LLED1000-96RGBW	1000W	96	TS25/TS40/TS60	870*820*165	32	182	364

Remark:
Intelligent integrated driver: 5.5kg
Luminaire weight: 32kg



TG-163XL

Code	Power	LED Qty	Optics	Packing Size	Weight	Pcs/20"	Pcs/40"
LED chips - 3535/5050							
TG-163XLLED1500-576	1500W	576	R1/R2/R3/T50/T90	Luminaire: 1150*870*165 Body:	42	134	278
TG-163XLLED1800-576	1800W	576	R1/R2/R3/T50/T90	1150*870*165	42	134	278
LED chips - XHP50							
TG-163XLLED1200-144	1200W	144	AH1/AH3	1150*870*165	42	134	278
TG-163XLLED1500-144	1500W	144	AH1/AH3	1150*870*165	42	134	278
LED chips - XML COLOUR							
TG-163XLLED1500-144RGBW	1500W	144	TS25/TS40/TS60	1150*870*165	42	134	278

Remark:
Intelligent integrated driver: 6kg
Luminaire weight: 42kg



TG-163 PROJECTS

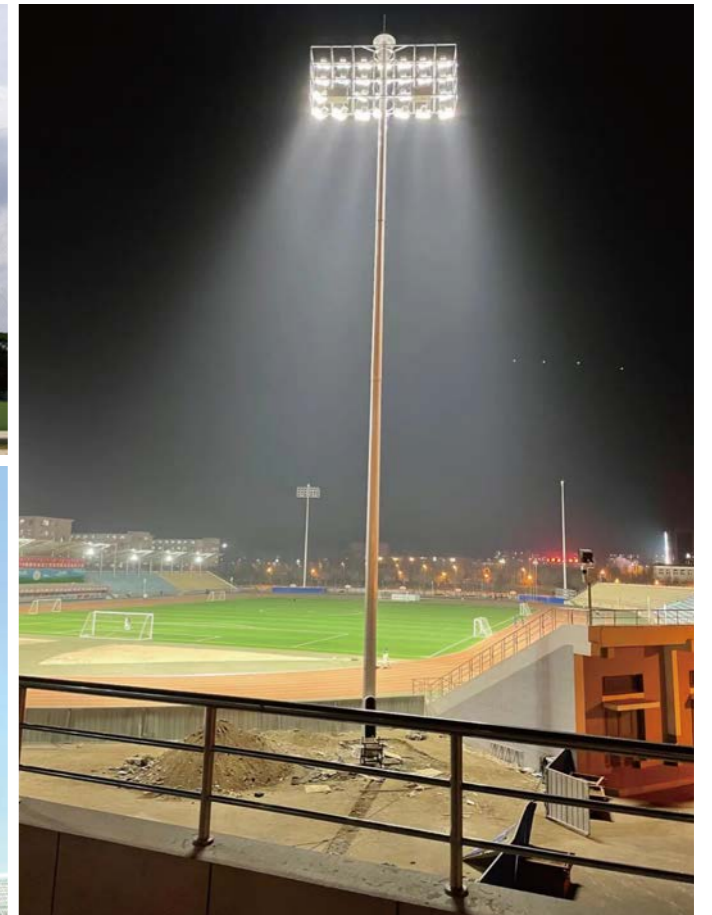

延伸产品 More in family



F-163S

For High Bay Lighting: 300~480W.



TG-161S1
40-100W



TG-161S
100-200W



TG-161M
200-300W



TG-161L
320-480W





简述 Description



- 灯具外壳采用铝合金压铸而成，灯具电器箱和光源模组采用分离式独立结构
 - 高透光PC透镜，具有高视觉舒适性和均匀配光透镜，供多种不同配光选择
 - 电器箱采用独特设计，安全快捷开启，整体防护IP66
 - 防紫外线聚氨酯塑粉喷涂表面，盐雾测试可以达1000小时以上
 - 无生物蓝光危害风险，符合EN62471: 2008标准
 - 所有外部螺钉均为304不锈钢材质
- Die-casting aluminum alloy housing, the electrical box and light module adopt separate independent structure.
 - Optics with PC lens with high visual comfortable and uniform lighting distribution, multiple light distribution options.
 - The electrical box adopts unique design, safe and fast opening, and the overall protection is IP66.
 - Surface anti-ultraviolet pure polyester powder painting, Corrosion resistance can be more than 1000 hours.
 - No photo-biological risk, (no risk linked to infrared, blue light and UV radiation) in accordance with EN 62471:2008.
 - All external screws are made of 304 stainless steel.

抗振等级: 通过5G / 15Hz / 3轴各10万次振动测试
 风压测试: >65m/s
 功率: 40W-480W
 光效: 110-135 Lm/W
 色温: 3000K / 4000K / 5000K
 显色指数: >80Ra / 90Ra
 功能选项: 0-10V / DALI / DMX / RGBW

Anti vibration grade: Passed 100K times vibration tests of 5G / 15Hz / 3 axis.
 Wind pressure test: >65m/s
 Power: 40W-480W
 Nominal efficacy: 110-135 Lm/W
 CCT: 3000K / 4000K / 5000K
 CRI: >80Ra / 90Ra
 Options: 0-10V / DALI / DMX / RGBW

- 应用场合: 体育馆、港口码头、机场及大型建筑立面泛光照明
- Applications: Sport stadium, port, and larger building illumination.

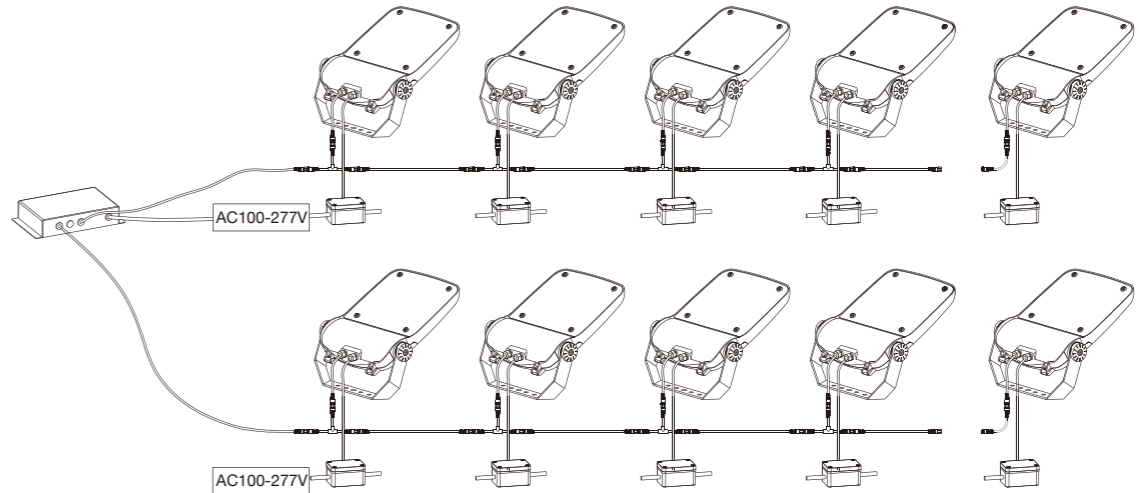



特殊散热翼形设计，有利于散热，不易积灰尘
Special heatsink design, it helps to have a good heat radiation and it have good cleaning effect by itself.



IK08钢化玻璃罩，可适配Zhaga标准PCB板，模组式透镜供多种不同光型可选，以满足不同场合的照明需求

IK08 tempered glass, it is suitable for zhaga standard PCB board. Modular lens is available for various light types to meet the lighting requirements of different place.



灯具安装时通过瞄准器精准控制光的投射位置，角度调整完毕后装上安全绳，能防止灯具的意外跌落

When installing lamps and lanterns, the projection position of the light is precisely controlled by the aiming sight, and the safety rope is installed after the angle adjustment, which can prevent the lamps and lanterns from falling unexpectedly.



TG-161 Series

一组实用型高端LED投光灯，灯具共有4个尺寸版本，分别功率从40W-480W，可适用于不同场合功能照明需求，多种光学系统可选配。

A practical high-end LED flood lighting with 4 sizes to option, and the power from 40W to 480W. It can be used for lighting requirements of different application scenarios. A variety of optical systems can be selected.

4
SIZES



独立电气室隔离，快速拆卸尾盖设计，电气安装维护安全方便

Isolation of independent electrical housing, plug-cover design, safety and convenience for the maintenance of electrical.



"L" 型灯具安装支架设有不锈钢刻度面板，并设有塑料装饰盖

"L" version luminaire mounting bracket with stainless steel scale panel and plastic decorative cover.

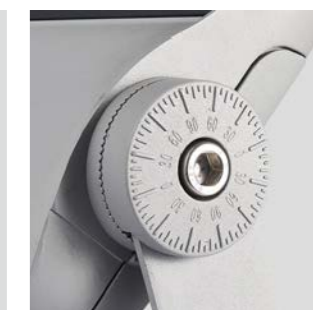

精准角度调节，其他尺寸灯具设有铝压铸刻度装饰盘

Precision angle adjustment, "other size luminaire with aluminum die casting scale decorative plate.

不对称反光杯 Asymmetric reflector optics

"A" reflector only suit for "L" and "M" version

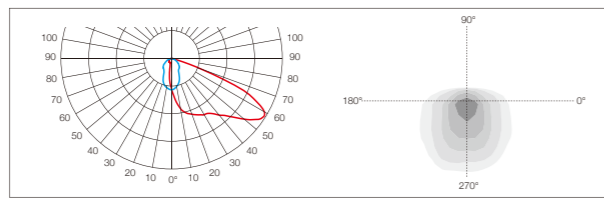

AH1
适用于运动场、广场、十字路口、停车场等区域照明
Asymmetrical Optic 40° * 70°
For sports ground, square, intersection, parking and other areas.

LED Chips: 4 in 1

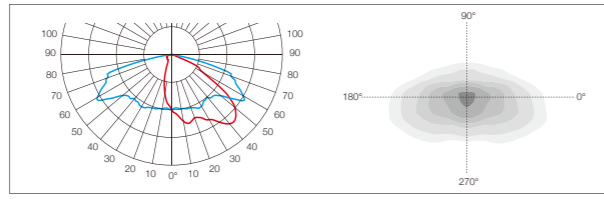

AH3
适用于运动场、广场、十字路口、停车场等区域照明
Asymmetrical Optic TYPE II
For sports ground, square, intersection, parking and other areas.

LED Chips: 4 in 1

组合不对称透镜 Asymmetric lens optics

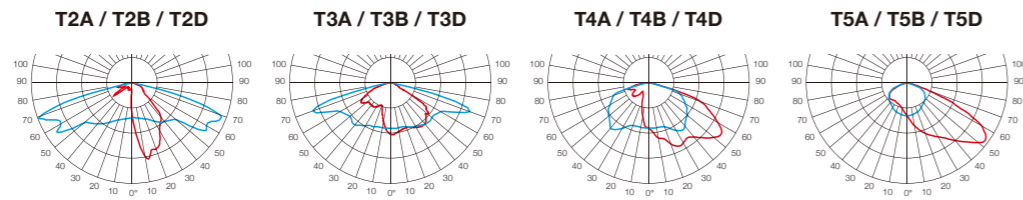

组合对称透镜 Symmetric lens optics

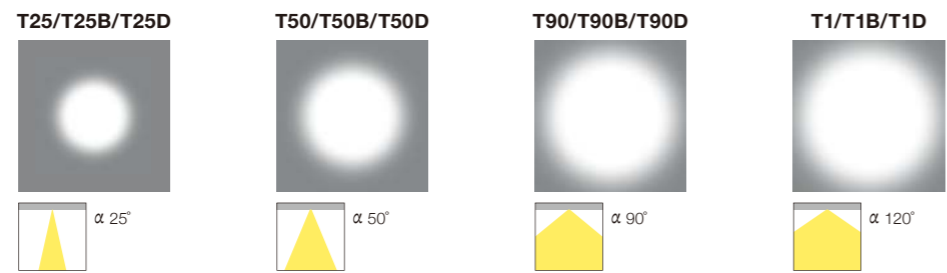

对称反光杯 Symmetric reflector optics

"R" reflector only suit for "L" and "M" version

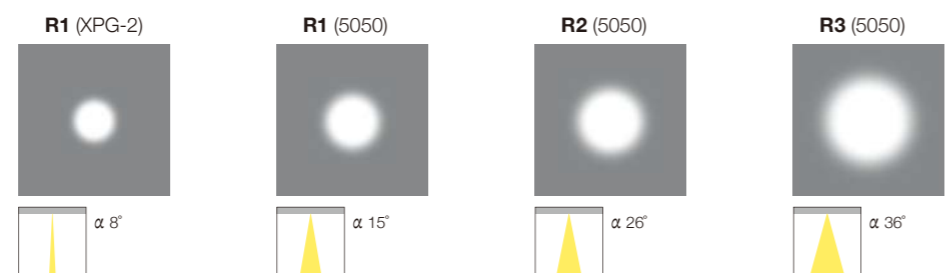
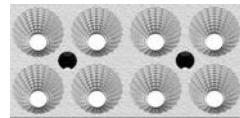

技术参数 Technology data



TG-161L

Code	Power	LED Qty	Optics	Packing Size	Weight	Pcs/20"	Pcs/40"
LED chips - 3535/5050							
TG-161LLED320-120	320W	120	T10/T25/T50/T90/T3A/T4A	785*610*165	19.4	325	689
TG-161LLED400-144	400W	144	T10/T25/T50/T90/T3A/T4A	785*610*165	19.8	325	689
TG-161LLED480-168	480W	168	T10/T25/T50/T90/T3A/T4A	785*610*165	19.8	325	689
LED chips - XHP50							
TG-161LLED320-48	320W	48	AH1/AH3	785*610*165	19.8	325	689
TG-161LLED420-48	420W	48	AH1/AH3	785*610*165	19.8	325	689
LED chips - XML COLOUR							
TG-161LLED480-48RGBW	480W	48	TS25/TS40/TS60	785*610*165	19.8	325	689

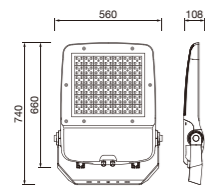

TG-161M

Code	Power	LED Qty	Optics	Packing Size	Weight	Pcs/20"	Pcs/40"
LED chips - 3535/5050							
TG-161MLED200-80	200W	80	T10/T25/T50/T90/T3A/T4A	660*470*115	12.0	738	1548
TG-161MLED240-96	240W	96	T10/T25/T50/T90/T3A/T4A	660*470*115	12.1	738	1548
TG-161MLED300-96	300W	96	T10/T25/T50/T90/T3A/T4A	660*470*115	12.2	738	1548
LED chips - XPE							
TG-161MLED240-96RGBW-S	240W	96	T1/TP25/TP40/TP60	660*470*115	13.0	738	1548

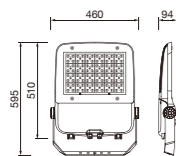

TG-161S

Code	Power	LED Qty	Optics	Packing Size	Weight	Pcs/20"	Pcs/40"
LED chips - 3535/5050							
TG-161SLED120-36	120W	36	T25/T50/T90/T1/T3A	500*395*110	8.2	1344	2898
TG-161SLED150-48	150W	48	T25/T50/T90/T1/T3A	500*395*110	8.2	1344	2898
TG-161SLED200-72	200W	72	T25D/T50D/T90D/T1D/T3D	500*395*110	8.2	1344	2898
LED chips - 3030							
TG-161SLED120-126	120W	126	T25B/T50B/T90B/T1B/T3B	500*395*110	7.9	1344	2898
TG-161SLED150-168	150W	168	T25B/T50B/T90B/T1B/T3B	500*395*110	7.9	1344	2898
TG-161SLED200-210	200W	210	T25B/T50B/T90B/T1B/T3B	500*395*110	7.9	1344	2898
LED chips - XPE							
TG-161SLED150-48RGBW-S	150W	48	T1/TP25/TP40/TP60	500*395*110	8.2	1344	2898

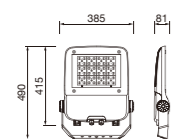

TG-161S1

Code	Power	LED Qty	Optics	Packing Size	Weight	Pcs/20"	Pcs/40"
LED chips - 3535/5050							
TG-161S1LED40-24	40W	24	T25/T50/T90/T1/T3A	400*295*105	3.6	2420	5038
TG-161S1LED60-24	60W	24	T25/T50/T90/T1/T3A	400*295*105	3.6	2420	5038
TG-161S1LED75-36	75W	36	T25/T50/T90/T1/T3A	400*295*105	4.0	2420	5038
TG-161S1LED100-36	100W	36	T25/T50/T90/T1/T3A	400*295*105	4.0	2420	5038
LED chips - 3030							
TG-161S1LED75-84	75W	84	T25B/T50B/T90B/T1B/T3B	400*295*105	4.0	2420	5038
TG-161S1LED100-126	100W	126	T25B/T50B/T90B/T1B/T3B	400*295*105	4.0	2420	5038
LED chips - XPE							
TG-161S1LED75-36RGBW-S	75W	36	T1/TP25/TP40/TP60	400*295*105	4.0	2420	5038

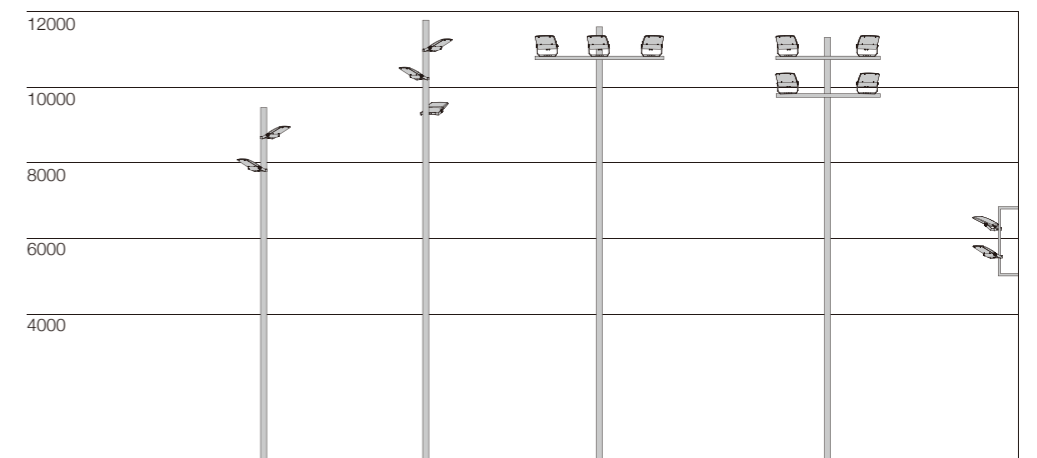
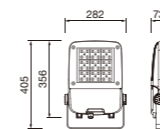





TG-202 Series



TG-202S
75-150W



TG-202M
150-240W



一款经典设计的圆形投射灯，外形简洁，功能齐全，可用于广场、码头及建筑立面照明等场所，灯具功率75W-240W。

A classic design of round projection luminaire, simple shape, complete functions, can be used in squares, wharves and construction of building lighting, lighting power for 75W-240W.

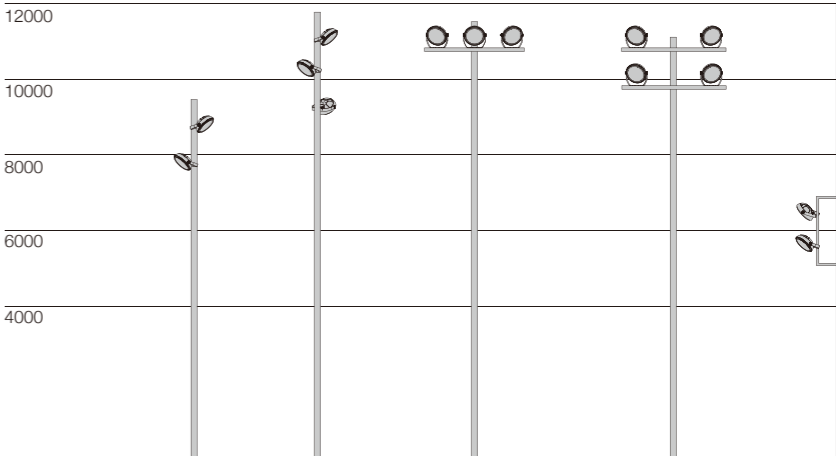

TG-202 Series

简述 Description



- 铝压铸灯体外壳，超白钢化玻璃，特殊外形设计，有2种尺寸供选择
 - 高透光PC透镜，多种光学组件可选，具有高视觉舒适性和防眩效果
 - 高性能LED芯片，有ON-OFF / DALI / DMX / RGBW多种控制程序选项
 - 灯具具有不同支架选项，可根据需要选配适用在不同场所
 - 防紫外线聚氨酯粉末喷涂表面，耐腐蚀可以达到1000小时以上
 - 无生物蓝光危害风险，符合EN62471: 2008标准
 - 所有外部螺钉均为304不锈钢材质
- Die-casting aluminium body, super white tempered glass. Special shape design, it has 2 sizes version options.
 - Optics with PC lens with high visual comfortable and good anti glare effect, multiple light distribution options.
 - High quality LED chips, with ON-OFF/DALI/ DMX/RGBW programmed options.
 - The luminaire have multiple brackets to option, it can suit different application.
 - Surface anti-ultraviolet pure polyester powder painting, Corrosion resistance can be more than 1000 hours.
 - No photo-biological risk, in accordance with EN 62471:2008.
 - All external screws are made of 304 stainless steel.

光学选项 Optical accessories

灯具拥有多款光学配件可选用，为视觉舒适性提供最有效的照明解决方案，避免不必要的眩光并减少光污染

The design has a variety of optical accessories to option, providing the most effective lighting solution for visual comfort, avoiding unnecessary glare and reducing light pollution.



Normally Type
TS透镜，不带防眩罩
With "TS" lens but without visior
TG-202S / TG-202M



"A" Type
TS透镜，带防眩罩
With "TS" lens but with visior
TG-202SA / TG-202MA



"B" Type
组合透镜，不带防眩罩
With combination lens, without visior
TG-202SB / TG-202MB

组合对称透镜 Symmetric lens optics

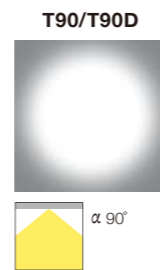
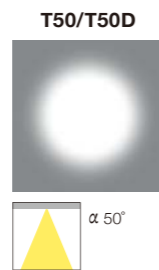

单颗对称透镜 Beam lens optics

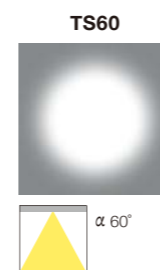
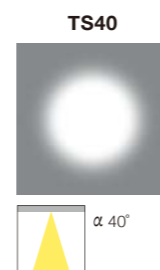
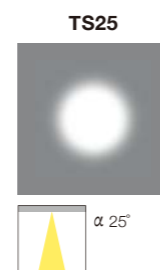

技术参数 Technology data



TG-202M

Code	Power	LED Qty	Optics	Packing Size	Weight	Pcs/20"	Pcs/40"
LED chips - 3535/5050							
TG-202MLED150-60	150W	60	TS4/TS15/TS25/TS40/TS60	500*495*205	11.2	500	1100
TG-202MLED200-84	200W	84	TS4/TS15/TS25/TS40/TS60	500*495*205	11.5	500	1100
LED chips - RGBW							
TG-202MLED240-84RGBW	240W	84	TS15/TS25/TS40/TS60	500*495*205	12.8	500	1100

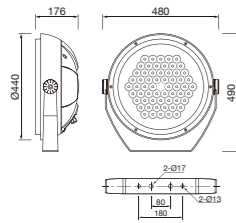

TG-202MA

Code	Power	LED Qty	Optics	Packing Size	Weight	Pcs/20"	Pcs/40"
LED chips - 3535/5050							
TG-202MALED150-60	150W	60	TS4/TS15/TS25/TS40/TS60	500*495*205	11.2	500	1100
TG-202MALED200-84	200W	84	TS4/TS15/TS25/TS40/TS60	500*495*205	11.5	500	1100
LED chips - RGBW							
TG-202MALED240-84RGBW	240W	84	TS15/TS25/TS40/TS60	500*495*205	12.8	500	1100

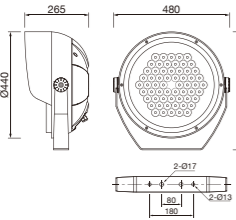

TG-202MB

Code	Power	LED Qty	Optics	Packing Size	Weight	Pcs/20"	Pcs/40"
LED chips - 3535/5050							
TG-202MBLED150-48	150W	48	T25/T50/T90/T1/T3A/T4A	500*495*205	11.5	500	1100
TG-202MBLED200-64	200W	64	T25/T50/T90/T1/T3A/T4A	500*495*205	11.5	500	1100

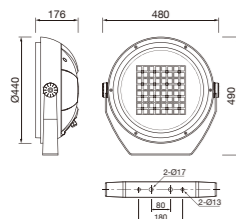

TG-202S

Code	Power	LED Qty	Optics	Packing Size	Weight	Pcs/20"	Pcs/40"
LED chips - 3535/5050							
TG-202SLED75-24	75W	24	TS4/TS15/TS25/TS40/TS60	390*390*190	8.1	770	1650
TG-202SLED100-36	100W	36	TS4/TS15/TS25/TS40/TS60	390*390*190	8.3	770	1650
TG-202SLED120-36	120W	36	TS4/TS15/TS25/TS40/TS60	390*390*190	8.6	770	1650
LED chips - RGBW							
TG-202SLED150-36RGBW	150W	36	TS15/TS25/TS40/TS60	390*390*190	8.8	770	1650

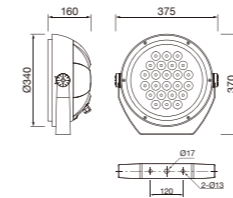

TG-202SA

Code	Power	LED Qty	Optics	Packing Size	Weight	Pcs/20"	Pcs/40"
LED chips - 3535/5050							
TG-202SALED75-24	75W	24	TS4/TS15/TS25/TS40/TS60	390*390*190	8.1	770	1650
TG-202SALED100-36	100W	36	TS4/TS15/TS25/TS40/TS60	390*390*190	8.3	770	1650
TG-202SALED120-36	120W	36	TS4/TS15/TS25/TS40/TS60	390*390*190	8.6	770	1650
LED chips - RGBW							
TG-202SALED150-36RGBW	150W	36	TS15/TS25/TS40/TS60	390*390*190	8.8	770	1650

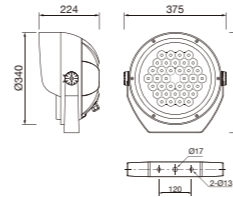

TG-202SB

Code	Power	LED Qty	Optics	Packing Size	Weight	Pcs/20"	Pcs/40"
LED chips - 3535/5050							
TG-202SBLED75-36	75W	36	T25/T50/T90/T1/T3A/T4A	390*390*190	7.3	770	1650
TG-202SBLED100-36	100W	36	T25/T50/T90/T1/T3A/T4A	390*390*190	7.6	770	1650
TG-202SBLED120-48	120W	48	T25/T50/T90/T1/T3A/T4A	390*390*190	7.6	770	1650

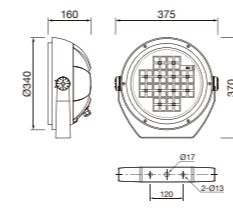

延伸产品 More in family



D-202MS / D-202SS
Street Lighting: 60~150W.



D-202MH / D-202SH
Street Lighting: 30~150W.



T-202SS
Street Lighting: 30~60W.



F-202M / F-202S
Highbay Lighting: 75~240W.
Page. 88



TG-162 Series



TG-162
100-200W

简述 Description



- 铝压铸灯体外壳，超白钢化玻璃，特殊外形设计，有3种光学系统供选择
- 高性能LED芯片，有ON-OFF / DALI / DMX多种控制程序选项
- 防紫外线聚氨酯塑粉喷涂表面，耐腐蚀可以达到1000小时以上
- 无生物蓝光危害风险，符合EN62471: 2008标准
- 所有外部螺钉均为304不锈钢材质
- Die-casting aluminium body, super white tempered glass. Special shape design, it has 3 type optical options.
- High quality LED chips, with ON-OFF/DALI/ DMX programmed options.
- Surface anti-ultraviolet pure polyester powder painting, Corrosion resistance can be more than 1000 hours.
- No photo-biological risk, in accordance with EN 62471:2008.
- All external screws are made of 304 stainless steel.

功率: 100W-200W
光效: 110-145 Lm/W
色温: 3000K / 4000K / 5000K
显色指数: >70Ra / 80Ra / 90Ra
功能选项: ON-OFF / DALI / DMX

Power: 100W-200W
Nominal efficacy: 110-145 Lm/W
CCT: 3000K / 4000K / 5000K
CRI: >70Ra / 80Ra / 90Ra
Options: ON-OFF / DALI / DMX

- 应用场合: 广场、建筑物、雕塑、标志物、广告牌等景观照明场所
- Applications: For landscape lighting places such as square, buildings, sculptures, signs and billboards.

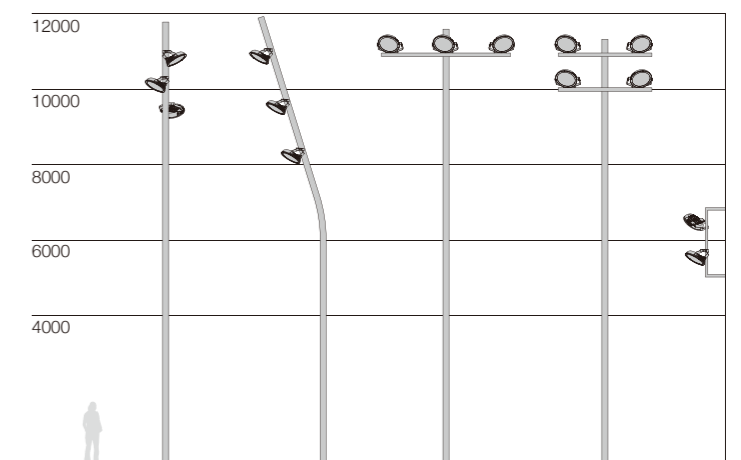

TG-162A / 不对称反光杯 Asymmetric reflector optics

"A" reflector only suit for "L" and "M" version

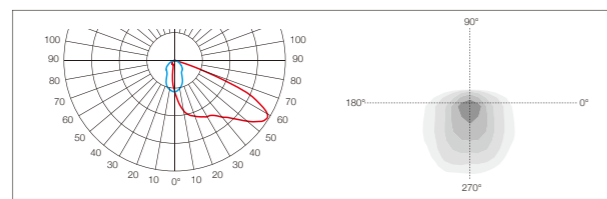

AH1
适用于运动场、广场、十字路口、停车场等区域照明
Asymmetrical Optic 40° * 70°
For sports ground, square, intersection, parking and other areas.

LED Chips: 4 in 1

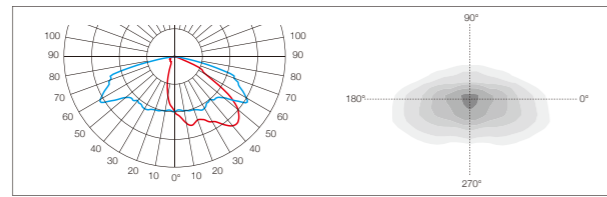

AH3
适用于运动场、广场、十字路口、停车场等区域照明
Asymmetrical Optic TYPE II
For sports ground, square, intersection, parking and other areas.

LED Chips: 4 in 1

TG-162L / 组合不对称透镜 Asymmetric lens optics

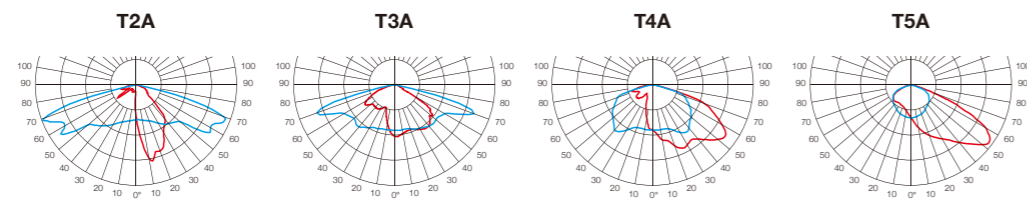

TG-162L / 组合对称透镜 Symmetric lens optics

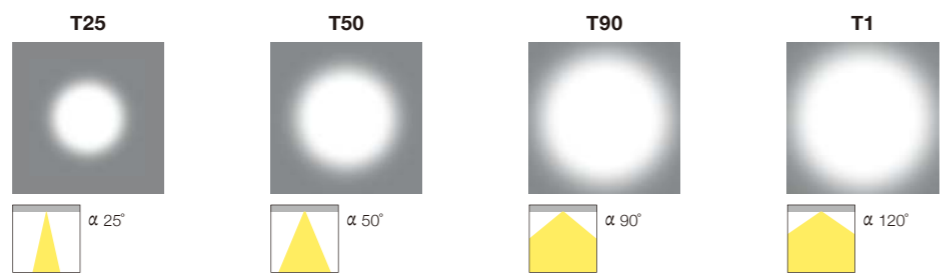

TG-162R / 对称反光杯 Symmetric reflector optics

"R" reflector only suit for "L" and "M" version

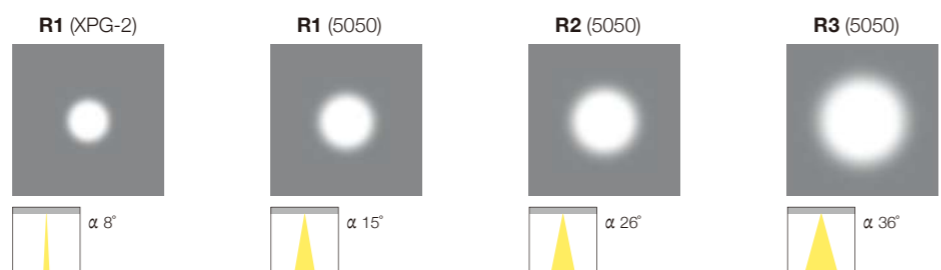
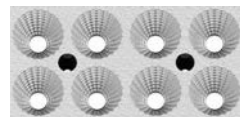

技术参数 Technology data



TG-162A

Code	Power	LED Qty	Optics	Packing Size	Weight	Pcs/20"	Pcs/40"
LED chips - 5050							
TG-162ALED100-48	100W	48	AH1/AH3	560*545*145	13.5	640	1408
TG-162ALED120-48	120W	48	AH1/AH3	560*545*145	13.5	640	1408
TG-162ALED150-60	150W	60	AH1/AH3	560*545*145	13.5	640	1408
TG-162ALED180-60	180W	60	AH1/AH3	560*545*145	13.5	640	1408

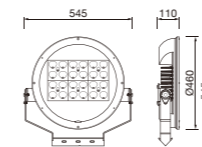

TG-162L

Code	Power	LED Qty	Optics	Packing Size	Weight	Pcs/20"	Pcs/40"
LED chips - 3535/5050							
TG-162LLED100-48	100W	48	T25/T50/T90/T1/T2A/T3A/T4A/T5A	560*545*145	13.0	640	1408
TG-162LLED120-48	120W	48	T25/T50/T90/T1/T2A/T3A/T4A/T5A	560*545*145	13.0	640	1408
TG-162LLED150-60	150W	60	T25/T50/T90/T1/T2A/T3A/T4A/T5A	560*545*145	13.0	640	1408
TG-162LLED180-60	180W	60	T25/T50/T90/T1/T2A/T3A/T4A/T5A	560*545*145	13.0	640	1408

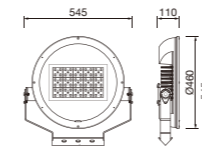

TG-162R

Code	Power	LED Qty	Optics	Packing Size	Weight	Pcs/20"	Pcs/40"
LED chips - 3535/5050							
TG-162RLED150-72	150W	72	R1/R2/R3	560*545*145	13.0	640	1408
TG-162RLED180-72	180W	72	R1/R2/R3	560*545*145	13.0	640	1408
TG-162RLED200-72	200W	72	R1/R2/R3	560*545*145	13.5	640	1408

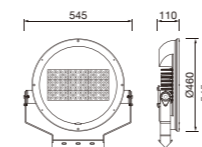

延伸产品 More in family



D-162S

Street Lighting: 100~150W.



F-162

Highbay Lighting: 100~150W.



TG-120S1
25-40W



TG-120S1N
40-75W

简述 Description

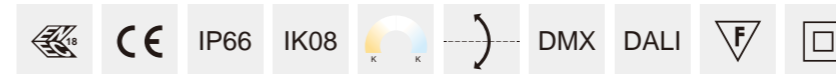

- 铝压铸灯体外壳，超白钢化玻璃，特殊外形设计，有3种光学系统供选择
- 高性能LED芯片，有ON-OFF / DALI / DMX多种控制程序选项
- 防紫外线聚氨酯塑粉喷涂表面，耐腐蚀可以达1000小时以上
- 无生物蓝光危害风险，符合EN62471: 2008标准
- 所有外部螺钉均为304不锈钢材质

- Die-casting aluminium body, super white tempered glass. Special shape design, it has 3 type optical options.
- High quality LED chips, with ON-OFF/DALI/ DMX programmed options.
- Surface anti-ultraviolet pure polyester powder painting, Corrosion resistance can be more than 1000 hours.
- No photo-biological risk, in accordance with EN 62471:2008.
- All external screws are made of 304 stainless steel.

功率: 25W-75W
 光效: 110-145 Lm/W
 色温: 3000K / 4000K / 5000K
 显色指数: >70Ra / 80Ra / 90Ra
 功能选项: ON-OFF / DALI / DMX

Power: 25W-75W
 Nominal efficacy: 110-145 Lm/W
 CCT: 3000K / 4000K / 5000K
 CRI: >70Ra / 80Ra / 90Ra
 Options: ON-OFF / DALI / DMX

- 应用场合: 广场、建筑物、雕塑、标志物、广告牌等景观照明场所
- Applications: For landscape lighting places such as square, buildings, sculptures, signs and billboards.

安装应用 Applications

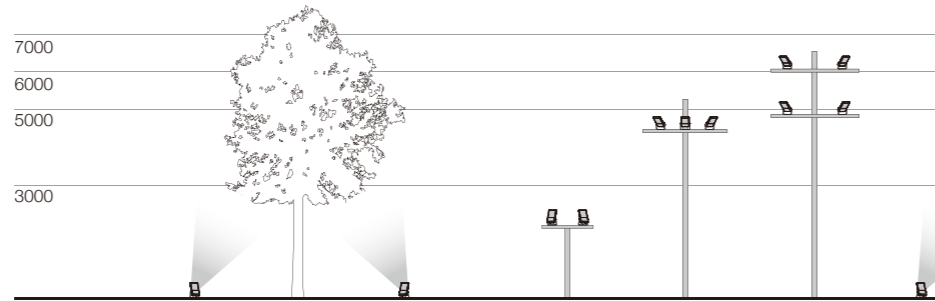

组合不对称透镜 Asymmetric lens optics



组合对称透镜 Symmetric lens optics

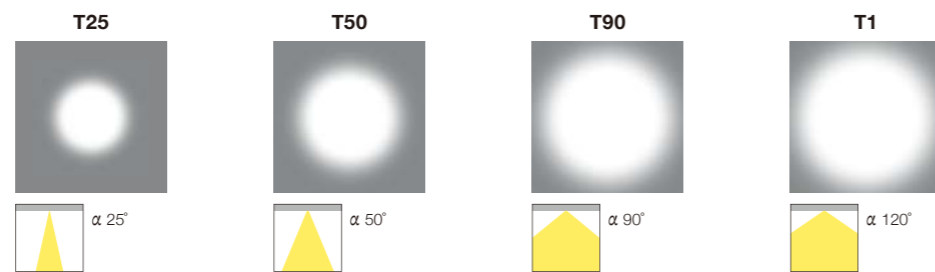

单颗透镜 Single lens optics

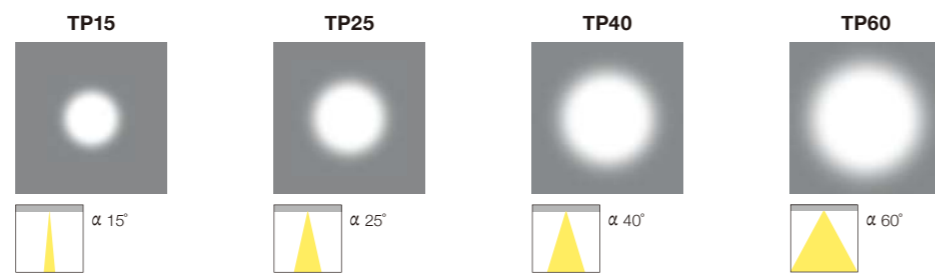

技术参数 Technology data



TG-120S1N

Code	Power	LED Qty	Optics	Packing Size	Weight	Pcs/20"	Pcs/40"
LED chips - 3535/5050							
TG-120S1NLED40-24	40W	24	T25/T50/T90/T1/T3A/T4A	420*270*85	4	2664	5520
TG-120S1NLED60-24	60W	24	T25/T50/T90/T1/T3A/T4A	420*270*85	4.1	2664	5520
TG-120S1NLED75-24	75W	24	T25/T50/T90/T1/T3A/T4A	420*270*85	4.1	2664	5520

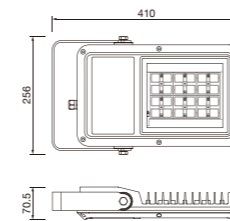

TG-120S1

Code	Power	LED Qty	Optics	Packing Size	Weight	Pcs/20"	Pcs/40"
LED chips - 3535/5050							
TG-120S1RLED25-16	25W	16	TP15/TP25/TP40/TP60	340*240*75	3.2	4226	8802
TG-120S1RLED50-16	50W	16	TP15/TP25/TP40/TP60	340*240*75	3.2	4226	8802

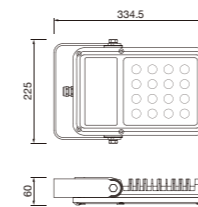

延伸产品 More in family



D-120MN / D-120SN

Street Lighting: 60~180W.



S-120MN / S-120SN

Tunnel Lighting: 60~180W.
Page. 84





TG-215S
15W



TG-215M
25-40W



TG-215L
60-75W

简述 Description



- 铝压铸灯体外壳，超白钢化玻璃，特殊外形设计，有3种尺寸供选择
- 高透光PC透镜，多种光学组件可选，具有高视觉舒适性和防眩效果
- 高性能LED芯片，有ON-OFF / DALI / DMX / RGBW多种控制程序选项
- 防紫外线聚氨酯塑粉喷涂表面，耐腐蚀可以达1000小时以上
- 无生物蓝光危害风险，符号EN62471: 2008标准
- 所有外部螺钉均为304不锈钢材质

- Die-casting aluminium body, super white tempered glass. Special shape design, it has 3 sizes version options.
- Optics with PC lens with high visual comfortable and good anti glare effect, multiple light distribution options.
- High quality LED chips, with ON-OFF/DALI/ DMX/RGBW programmed options.
- Surface anti-ultraviolet pure polyester powder painting, Corrosion resistance can be more than 1000 hours.
- No photo-biological risk, in accordance with EN 62471:2008.
- All external screws are made of 304 stainless steel.

功率: 15W-75W
 光效: 110-135 Lm/W
 色温: 3000K / 4000K / 5000K / 5700K
 显色指数: >80Ra / 90Ra
 功能选项: ON-OFF / DALI / DMX / RGBW

Power: 15W-75W
 Nominal efficacy: 110-135 Lm/W
 CCT: 3000K / 4000K / 5000K / 5700K
 CRI: >80Ra / 90Ra
 Options: ON-OFF / DALI / DMX / RGBW

- 应用场合: 广场、建筑物、雕塑、标志物、广告牌等景观照明场所
- Applications: For landscape lighting places such as square, buildings, sculptures, signs and billboards.

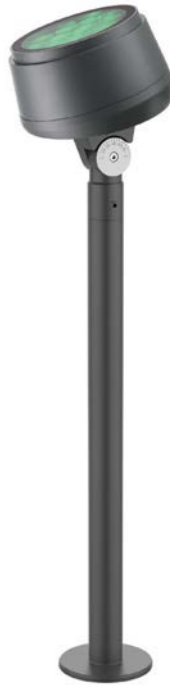

光学选项 Optical accessories

灯具拥有多款光学配件可选用，为视觉舒适性提供最有效的照明解决方案，避免不必要的眩光并减少光污染

The design has a variety of optical accessories to option, providing the most effective lighting solution for visual comfort, avoiding unnecessary glare and reducing light pollution.



Normally Type
装饰板 Decorative plate
TG-215S / TG-215M / TG-215L

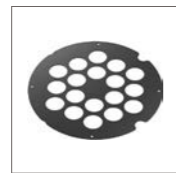

"A" Type
导光筒 Spill ring
TG-215SA / TG-215MA / TG-215LA



"B" Type
蜂窝板 Honeycomb louvre
TG-215SB / TG-215MB / TG-215LB

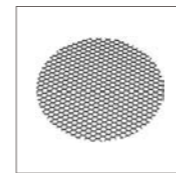

安装应用 Applications

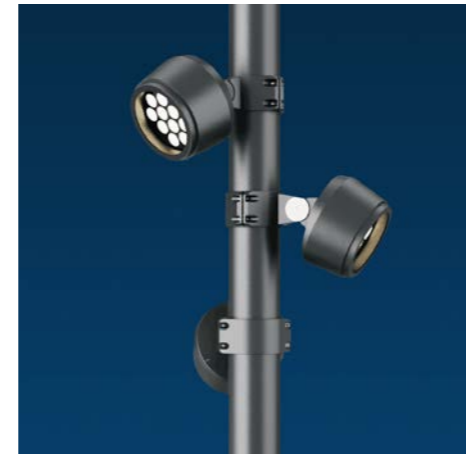
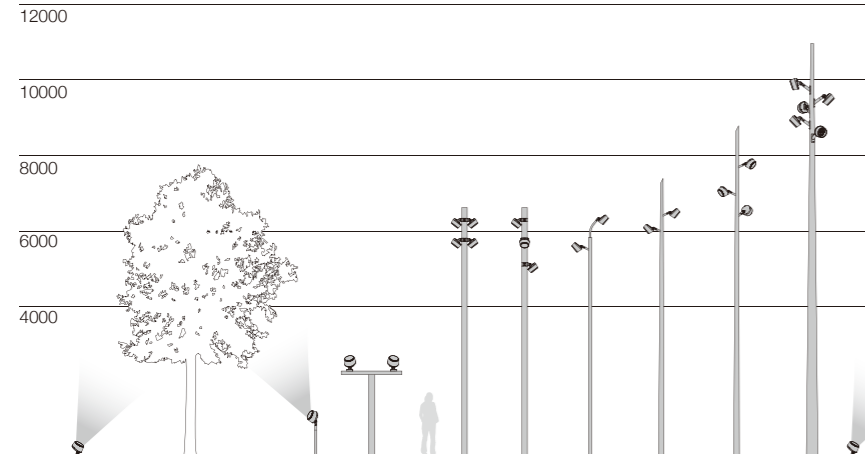

发光角度 Optics

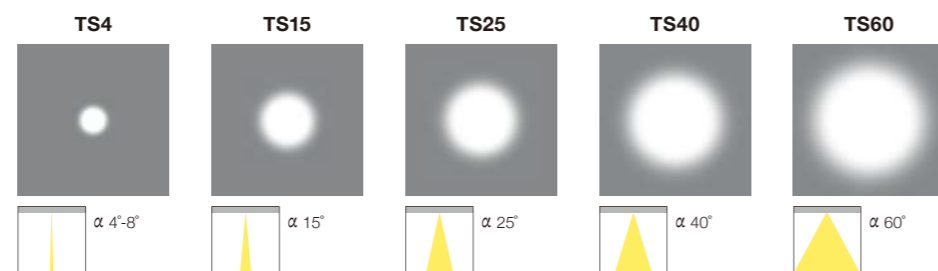

技术参数 Technology data



TG-215L

Code	Power	LED Qty	Optics	Packing Size	Weight	Pcs/20"	Pcs/40"
LED chips - 3535/5050							
TG-215LLED60-18	60W	18	TS4/TS15/TS25/TS40/TS60	575*295*320/2pcs	12.0	1064	2240
TG-215LLED75-18	75W	18	TS4/TS15/TS25/TS40/TS60	575*295*320/2pcs	12.0	1064	2240
LED chips - RGBW							
TG-215LLED75-18RGBW	75W	18	TS15/TS25/TS40/TS60	575*295*320/2pcs	12.2	1064	2240

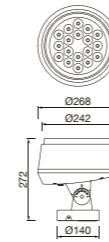

TG-215M

Code	Power	LED Qty	Optics	Packing Size	Weight	Pcs/20"	Pcs/40"
LED chips - 3535/5050							
TG-215MLED25-12	25W	12	TS4/TS15/TS25/TS40/TS60	475*245*305/2pcs	8.3	1512	3150
TG-215MLED40-12	40W	12	TS4/TS15/TS25/TS40/TS60	475*245*305/2pcs	8.3	1512	3150
LED chips - RGBW							
TG-215MLED40-12RGBW	40W	12	TS15/TS25/TS40/TS60	475*245*305/2pcs	8.5	1512	3150

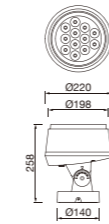

TG-215S

Code	Power	LED Qty	Optics	Packing Size	Weight	Pcs/20"	Pcs/40"
LED chips - 3535/5050							
TG-215SLED15-6	15W	6	TP15/TP25/TP40/TP60	285*285*235/4pcs	8.0	5760	11808
LED chips - RGBW							
TG-215SLED15-6RGBW	15W	6	TP15/TP25/TP40/TP60	285*285*235/4pcs	8.0	5760	11808

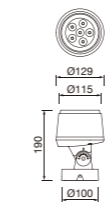

可选配件 Accessories options

	Code
灯杆抱箍1 Pole Hoop-1	210004845
灯杆抱箍2 Pole Hoop-2	210004846
灯杆连接叉 Pole Bracket	250000465
Ø48安装座 Fixing Arm	210003959



TG-213S
35-50W



TG-213M
60-75W

简述 Description



- 铝压铸灯体外壳，超白钢化玻璃，耐候PC塑料底座
- 高透光PC透镜，多种光学组件可选，具有高视觉舒适性和防眩效果
- 高性能LED芯片，有ON-OFF / DALI / DMX / RGBW多种控制程序选项
- 防紫外线聚氨酯塑粉喷涂表面，耐腐蚀可达1000小时以上
- 无生物蓝光危害风险，符合EN62471: 2008标准
- 所有外部螺钉均为304不锈钢材质
- Die-casting aluminium body, super white tempered glass, good weatherability PC plastic base.
- Optics with PC lens with high visual comfortable and good anti glare effect, multiple light distribution options.
- High quality LED chips, with ON-OFF/DALI/ DMX/RGBW programmed options.
- Surface anti-ultraviolet pure polyester powder painting, Corrosion resistance can be more than 1000 hours.
- No photo-biological risk, in accordance with EN 62471:2008.
- All external screws are made of 304 stainless steel.

功率: 35W-75W
 光效: 110-135 Lm/W
 色温: 3000K / 4000K / 5000K / 5700K
 显色指数: >80Ra / 90Ra
 功能选项: ON-OFF / DALI / DMX / RGBW

Power: 35W-75W
 Nominal efficacy: 110-135 Lm/W
 CCT: 3000K / 4000K / 5000K / 5700K
 CRI: >80Ra / 90Ra
 Options: ON-OFF / DALI / DMX / RGBW

- 应用场合: 明装功能性照明灯具-安装条件不允许嵌装、立面又需要照明效果或洗亮的照明场所
- Applications: Surface decoration functional luminaire-used for tree lighting, building facade lighting and others place.

光学选项 Optical accessories

灯具拥有多款光学配件可选用，为视觉舒适性提供最有效的照明解决方案，避免不必要的眩光并减少光污染

The design has a variety of optical accessories to option, providing the most effective lighting solution for visual comfort, avoiding unnecessary glare and reducing light pollution.

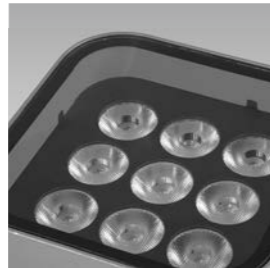

Normally Type
装饰板 Decorative plate
TG-213S / TG-213M



"A" Type
导光筒 Spill ring
TG-213SA / TG-213MA



"B" Type
蜂窝板 Honeycomb louvre
TG-213SB / TG-213MB



安装应用 Applications

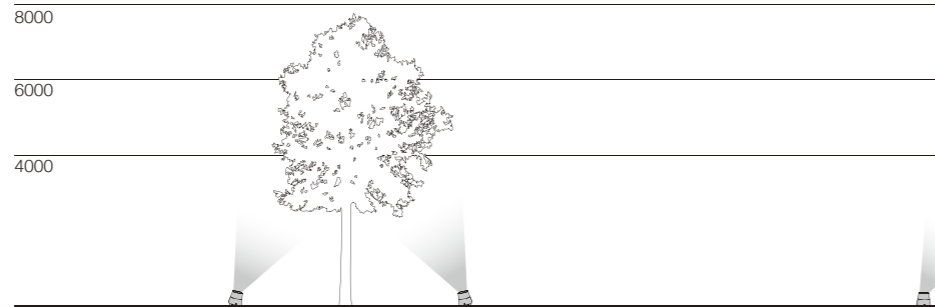

发光角度 Optics

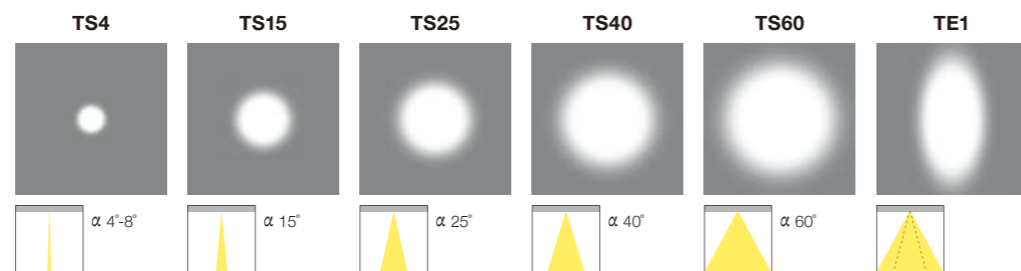

技术参数 Technology data



TG-213M

Code	Power	LED Qty	Optics	Packing Size	Weight	Pcs/20"	Pcs/40"
LED chips - 3535/5050							
TG-213MLED60-16	60W	16	TS4/TS15/TS25/TS40/TS60	570*290*330/2pcs	13.6	1078	2254
LED chips - RGBW							
TG-213MLED75-16RGBW	75W	16	TS15/TS25/TS40/TS60	570*290*330/2pcs	13.6	1078	2254

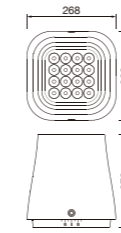

TG-213S

Code	Power	LED Qty	Optics	Packing Size	Weight	Pcs/20"	Pcs/40"
LED chips - 3535/5050							
TG-213SLED35-9	35W	9	TS4/TS15/TS25/TS40/TS60	450*220*260/2pcs	8.0	1920	4160
LED chips - RGBW							
TG-213SLED50-9RGBW	50W	9	TS15/TS25/TS40/TS60	450*220*260/2pcs	8.0	1920	4160

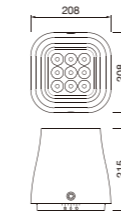

安装说明 Installation



通过调节固定螺钉，灯具可以实现左右和水平角度调节

By adjusting the fixing screw, the lighting can realize the left and right and horizontal angle adjustment.



TG-211S
25-50W



TG-211M
50-100W

简述 Description



- 铝压铸灯体外壳，超白钢化玻璃，特殊外形设计，有2种尺寸供选择
- 高透光PC透镜，多种光学组件可选，具有高视觉舒适性和防眩效果
- 高性能LED芯片，有ON-OFF / DALI / DMX / RGBW多种控制程序选项
- 防紫外线聚氨酯塑粉喷涂表面，耐腐蚀可以达1000小时以上
- 无生物蓝光危害风险，符号EN62471: 2008标准
- 所有外部螺钉均为304不锈钢材质

- Die-casting aluminium body, super white tempered glass. Special shape design, it has 2 sizes version options.
- Optics with PC lens with high visual comfortable and good anti glare effect, multiple light distribution options.
- High quality LED chips, with ON-OFF/DALI/ DMX/RGBW programmed options.
- Surface anti-ultraviolet pure polyester powder painting, Corrosion resistance can be more than 1000 hours.
- No photo-biological risk, in accordance with EN 62471:2008.
- All external screws are made of 304 stainless steel.

功率: 25W-100W
 光效: 110-135 Lm/W
 色温: 3000K / 4000K / 5000K / 5700K
 显色指数: >80Ra / 90Ra
 功能选项: ON-OFF / DALI / DMX / RGBW

Power: 25W-100W
 Nominal efficacy: 110-135 Lm/W
 CCT: 3000K / 4000K / 5000K / 5700K
 CRI: >80Ra / 90Ra
 Options: ON-OFF / DALI / DMX / RGBW

- 应用场合: 建筑物、雕塑、标志物、广告牌等景观照明场所
- Applications: For landscape lighting places such as buildings, sculptures, signs and billboards.

光学选项 Optical accessories

灯具拥有多款光学配件可选用，为视觉舒适性提供最有效的照明解决方案，避免不必要的眩光并减少光污染

The design has a variety of optical accessories to option, providing the most effective lighting solution for visual comfort, avoiding unnecessary glare and reducing light pollution.



Normally Type
装饰板 Decorative plate
TG-211S / TG-211M



"A" Type
导光筒 Spill ring
TG-211SA / TG-211MA



"B" Type
蜂窝板 Honeycomb louvre
TG-211SB / TG-211MB



安装应用 Applications

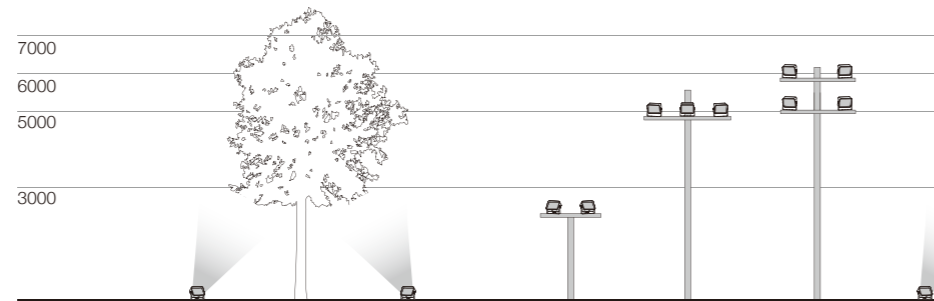

发光角度 Optics

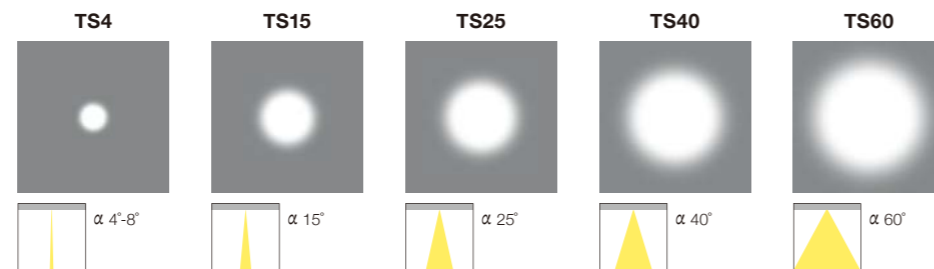

技术参数 Technology data

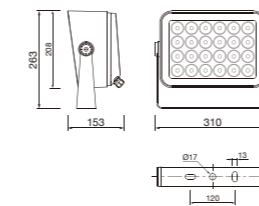

TG-211M

Code	Power	LED Qty	Optics	Packing Size	Weight	Pcs/20"	Pcs/40"
LED chips - 3535/5050							
TG-211MLED50-24	50W	24	TS4/TS15/TS25/TS40/TS60	335*335*295/2pcs	11.4	1428	2940
TG-211MLED75-24	75W	24	TS4/TS15/TS25/TS40/TS60	335*335*295/2pcs	11.4	1428	2940
LED chips - RGBW							
TG-211MLED100-24RGBW	100W	24	TS15/TS25/TS40/TS60	335*335*295/2pcs	11.4	1428	2940

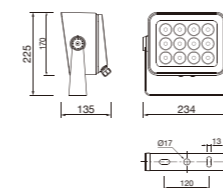

TG-211S

Code	Power	LED Qty	Optics	Packing Size	Weight	Pcs/20"	Pcs/40"
LED chips - 3535/5050							
TG-211SLED25-12	25W	12	TS4/TS15/TS25/TS40/TS60	295*255*255/2pcs	7.2	3060	6408
TG-211SLED40-12	40W	12	TS4/TS15/TS25/TS40/TS60	295*255*255/2pcs	7.2	3060	6408
LED chips - RGBW							
TG-211SLED50-12RGBW	50W	12	TS15/TS25/TS40/TS60	295*255*255/2pcs	7.2	3060	6408

可选配件 Accessories options

	Code
地插 Spike	230000103
基础埋件 Anchor Bolts	250000375
膨胀螺钉 Expansion Bolts	613040004





TG-13S
15W



TG-13M
25W

简述 Description



- 铝压铸灯体外壳，超白钢化玻璃，特殊外形设计，有2种尺寸供选择
- 高透光PC透镜，具有高视觉舒适性和均匀配光透镜，供多种不同配光选择
- 高性能LED芯片，有ON-OFF / DALI / DMX / RGBW多种控制程序选项
- 防紫外线聚氨酯塑粉喷涂表面，耐腐蚀可以达1000小时以上
- 无生物蓝光危害风险，符号EN62471: 2008标准
- 所有外部螺钉均为304不锈钢材质

- Die-casting aluminium body, super white tempered glass. Special shape design, it has 2 sizes version options.
- Optics with PC lens with high visual comfortable and good anti glare effect, multiple light distribution options.
- High quality LED chips, with ON-OFF/DALI/ DMX/RGBW programmed options.
- Surface anti-ultraviolet pure polyester powder painting, Corrosion resistance can be more than 1000 hours.
- No photo-biological risk, in accordance with EN 62471:2008.
- All external screws are made of 304 stainless steel.

功率: 15W-25W
 光效: 110-135 Lm/W
 色温: 3000K / 4000K / 5000K / 5700K
 显色指数: >80Ra / 90Ra
 功能选项: ON-OFF / DALI / DMX / RGBW

Power: 15W-25W
 Nominal efficacy: 110-135 Lm/W
 CCT: 3000K / 4000K / 5000K / 5700K
 CRI: >80Ra / 90Ra
 Options: ON-OFF / DALI / DMX / RGBW

- 应用场合: 建筑物、雕塑、标志物、广告牌等景观照明场所
- Applications: For landscape lighting places such as buildings, sculptures, signs and billboards.

发光角度 Optics

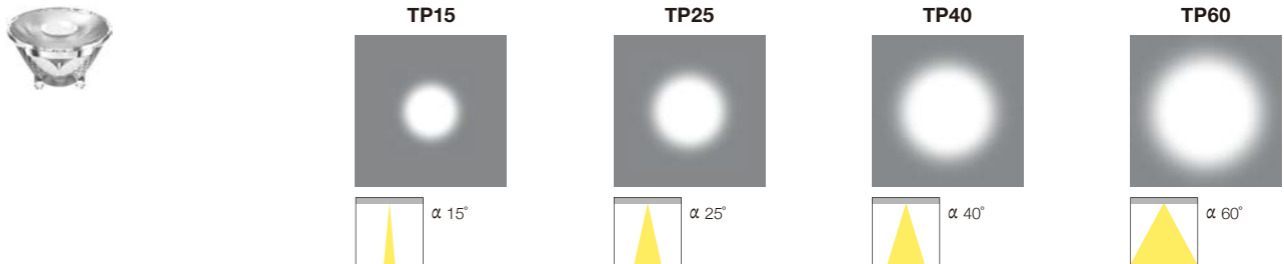



技术参数 Technology data



TG-13M

Code	Power	LED Qty	Optics	Packing Size	Weight	Pcs/20"	Pcs/40"
LED chips - 3535							
TG-13MLED25-9	25W	9	TP15/TP25/TP40/TP60	325*325*230/4pcs	8.0	4284	9072
LED chips - RGBW							
TG-13MLED25-9RGBW	25W	9	TP15/TP25/TP40/TP60	325*325*230/4pcs	8.0	4284	9072

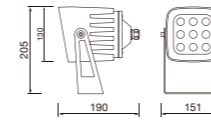

TG-13S

Code	Power	LED Qty	Optics	Packing Size	Weight	Pcs/20"	Pcs/40"
LED chips - 3535							
TG-13SLED15-5	15W	5	TP15/TP25/TP40/TP60	275*265*185/4pcs	4.5	8064	16896
LED chips - RGBW							
TG-13SLED15-5RGBW	15W	5	TP15/TP25/TP40/TP60	275*265*185/4pcs	4.5	8064	16896

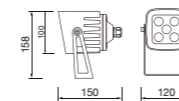

可选配件 Accessories options

	Code
地插 Spike	230000103
基础埋件 Anchor Bolts	250000375
膨胀螺钉 Expansion Bolts	613040004



TG-12 Series



TG-12S
9W



TG-12M
25W

简述 Description



- 铝压铸灯体外壳，超白钢化玻璃，特殊外形设计，有2种尺寸供选择
- 高透光PC透镜，具有高视觉舒适性和均匀配光透镜，供多种不同配光选择
- 高性能LED芯片，有ON-OFF / DALI / DMX / RGBW多种控制程序选项
- 防紫外线聚氨酯塑粉喷涂表面，耐腐蚀可以达1000小时以上
- 无生物蓝光危害风险，符号EN62471: 2008标准
- 所有外部螺钉均为304不锈钢材质

- Die-casting aluminium body, super white tempered glass. Special shape design, it has 2 sizes version options.
- Optics with PC lens with high visual comfortable and good anti glare effect, multiple light distribution options.
- High quality LED chips, with ON-OFF/DALI/ DMX/RGBW programmed options.
- Surface anti-ultraviolet pure polyester powder painting, Corrosion resistance can be more than 1000 hours.
- No photo-biological risk, in accordance with EN 62471:2008.
- All external screws are made of 304 stainless steel.

功率: 9W-25W
 光效: 110-135 Lm/W
 色温: 3000K / 4000K / 5000K / 5700K
 显色指数: >80Ra / 90Ra
 功能选项: ON-OFF / DALI / DMX / RGBW

Power: 9W-25W
 Nominal efficacy: 110-135 Lm/W
 CCT: 3000K / 4000K / 5000K / 5700K
 CRI: >80Ra / 90Ra
 Options: ON-OFF / DALI / DMX / RGBW

- 应用场合: 建筑物、雕塑、标志物、广告牌等景观照明场所
- Applications: For landscape lighting places such as buildings, sculptures, signs and billboards.

发光角度 Optics



TP15



α 15°

TP25



α 25°

TP40



α 40°

TP60

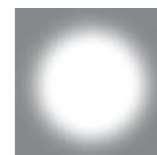

α 60°



技术参数 Technology data



TG-12M

Code	Power	LED Qty	Optics	Packing Size	Weight	Pcs/20"	Pcs/40"
LED chips - 3535 TG-12MLED25-9	25W	9	TP15/TP25/TP40/TP60	385*335*228/4pcs	10.6	3600	7380
LED chips - RGBW TG-12MLED25-9RGBW	25W	9	TP15/TP25/TP40/TP60	385*335*228/4pcs	10.6	3600	7380

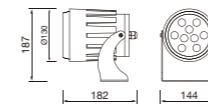

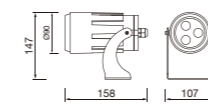

TG-12S

Code	Power	LED Qty	Optics	Packing Size	Weight	Pcs/20"	Pcs/40"
LED chips - 3535 TG-12SLED9-3	9W	3	TP15/TP25/TP40/TP60	295*265*205/4pcs	5.2	6480	13600
LED chips - RGBW TG-12SLED9-3RGBW	9W	3	TP15/TP25/TP40/TP60	295*265*205/4pcs	5.2	6480	13600



可选配件 Accessories options

	Code
 地插 Spike	230000103
 基础埋件 Anchor Bolts	250000375
 膨胀螺钉 Expansion Bolts	613040004



S-120SN
60-100W



S-120MN
100-180W

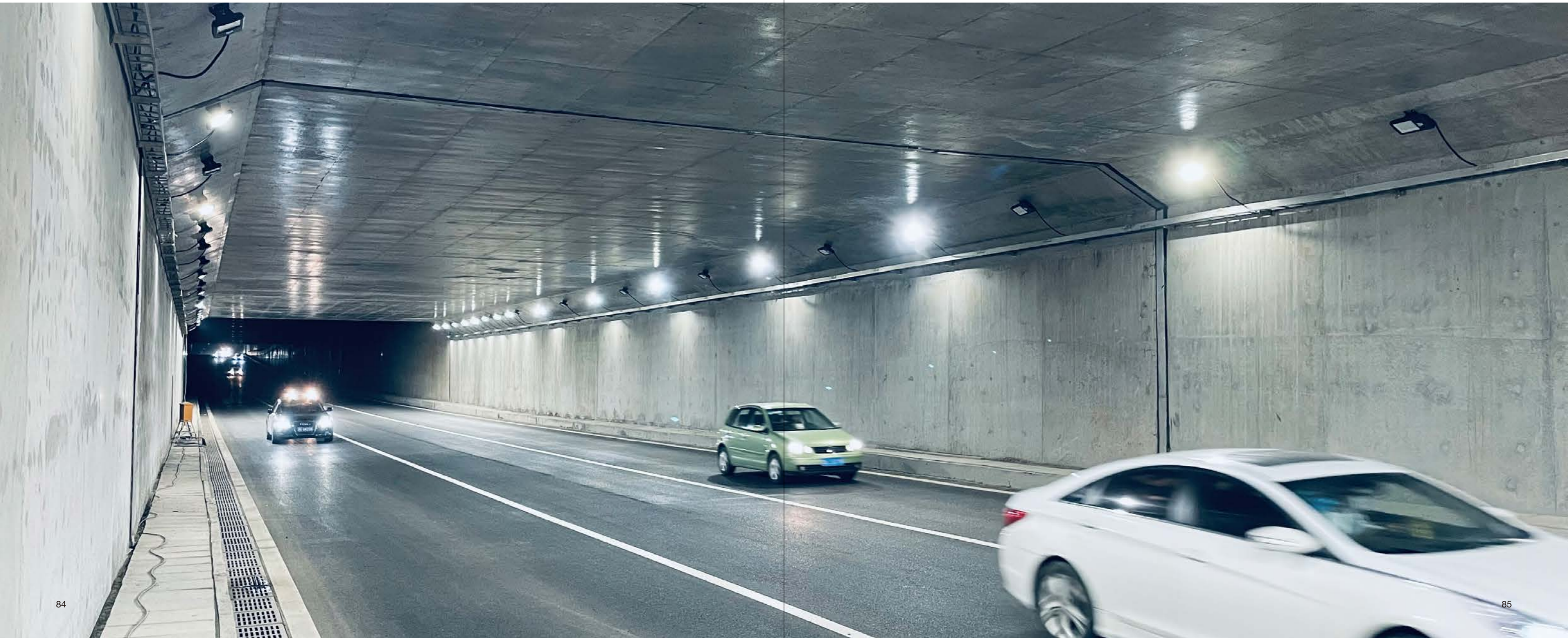

简述 Description



- 铝压铸灯体外壳，超白钢化玻璃，镀铬塑料反射罩
- 高透光PC透镜，具有高视觉舒适性和均匀配光透镜，供多种不同配光选择
- 高性能LED芯片，驱动有0-10V / DALI / 编程电源选择，20KV浪涌保护器
- 独立维修门设计，安装维修方便
- 灯具采用背面支架固定安装方式，角度可调
- 无生物蓝光危害风险，符合EN62471: 2008标准
- 道路灯智能远程控制系统可选，可以与远程管理系统兼容
- 所有外部螺钉均为304不锈钢材质

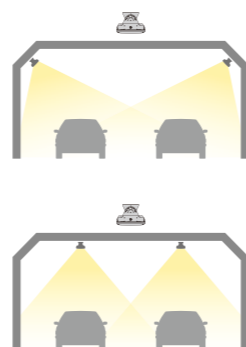

- Die-casting aluminium body, super white tempered glass, Chrome plastic reflector.
- Optics with PC lens with high visual comfortable and uniform lighting distribution, multiple light distribution options.
- High quality LED chips, Driver with 0-10V/DALI/programmed be options, and with surge protection up to 20KV.
- Independent maintenance door design, easy installation and maintenance.
- The luminaire is fixed by back bracket, and angle can be adjusted.
- No photo-biological risk, (no risk linked to infrared, blue light and UV radiation) in accordance with EN 62471:2008.
- Street lighting control used with smart control technology. It can be compatible with remote management system.
- All external screws are made of 304 stainless steel.

隧道光分布示意图 Light distribution



应用透镜 Optics application

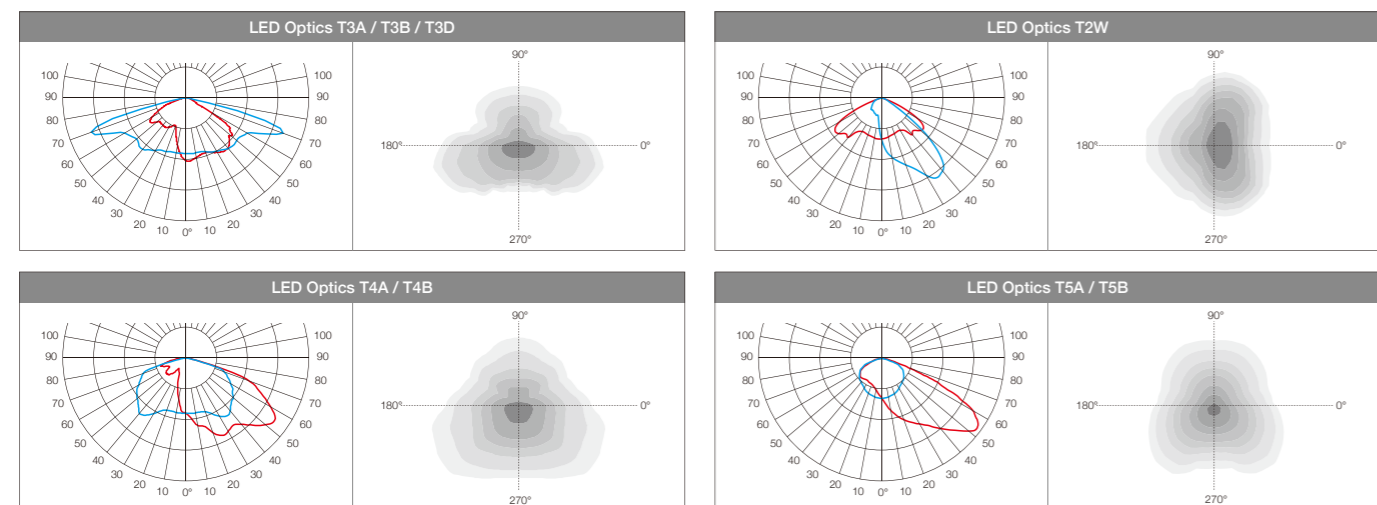

技术参数 Technology data



S-120MN

Code	Power	LED Qty	Optics	Packing Size	Weight	Pcs/20"	Pcs/40"
LED chips - 3535/5050							
S-120MNLED100-40	100W	40	T1/T2A/T3A/T4A	600*295*140	10.7	920	1940
S-120MNLED120-40	120W	40	T1/T2A/T3A/T4A	600*295*140	10.7	920	1940
S-120MNLED150-60	150W	60	T1/T2A/T3A/T4A	600*295*140	11.0	920	1940
S-120MNLED180-60	180W	60	T1/T2A/T3A/T4A	600*295*140	11.0	920	1940

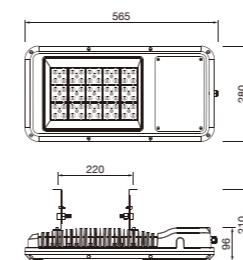

LED chips - 3030

S-120MNLED150-140	150W	140	T1B/T2B/T3B/T4B	600*295*140	11.0	920	1940
S-120MNLED180-210	180W	210	T1B/T2B/T3B/T4B	600*295*140	11.0	920	1940



S-120SN

Code	Power	LED Qty	Optics	Packing Size	Weight	Pcs/20"	Pcs/40"
LED chips - 3535/5050							
S-120SNLED60-24	60W	24	T1/T2A/T3A/T4A	490*270*115	6.4	1540	3184
S-120SNLED75-32	75W	32	T1/T2A/T3A/T4A	490*270*115	6.7	1540	3184
S-120SNLED100-32	100W	32	T1/T2A/T3A/T4A	490*270*115	7.0	1540	3184

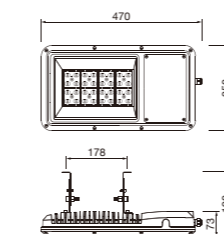

LED chips - 3030

S-120SNLED75-112	75W	112	T1B/T2B/T3B/T4B	490*270*115	7.0	1540	3184
S-150SNLED100-112	100W	112	T1B/T2B/T3B/T4B	490*270*115	7.0	1540	3184

延伸产品 More in family



D-120MN / D-120SN

Street Lighting: 60-180W.



TG-120S1 / TG-120S1N

Flood Lighting: 25-75W.
Page. 56



F-202 Series Highbay Lighting



F-202S
75-120W



F-202M
150-240W

简述 Description

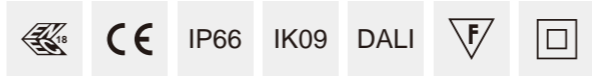

- 铝压铸灯体外壳，超白钢化玻璃，特殊外形设计，有2种尺寸供选择
- 高透光PC透镜，多种光学组件可选，具有高视觉舒适性和防眩效果
- 高性能LED芯片，有ON-OFF / DALI多种控制程序选项
- 灯具具有不同支架选项，可根据需要选配适用在不同场所
- 防紫外线聚氨酯塑料喷涂表面，耐腐蚀可以达1000小时以上
- 无生物蓝光危害风险，符号EN62471: 2008标准
- 所有外部螺钉均为304不锈钢材质

- Die-casting aluminium body, super white tempered glass. Special shape design, it has 2 sizes version options.
- Optics with PC lens with high visual comfortable and good anti glare effect, multiple light distribution options.
- High quality LED chips, with ON-OFF/DALI programmed options.
- The luminaire have multiple brackets to option, it can suit different application.
- Surface anti-ultraviolet pure polyester powder painting, Corrosion resistance can be more than 1000 hours.
- No photo-biological risk, in accordance with EN 62471:2008.
- All external screws are made of 304 stainless steel.

功率: 75W-240W
光效: 120-155 Lm/W
色温: 3000K / 4000K / 5000K
显色指数: >80Ra / 90Ra
功能选项: ON-OFF / DALI

Power: 75W-240W
Nominal efficacy: 120-155 Lm/W
CCT: 3000K / 4000K / 5000K
CRI: >80Ra / 90Ra
Options: ON-OFF / DALI

- 应用场合: 车间, 库房, 展览馆等场所等照明场所
- Applications: Workshop, warehouse, exhibition hall, etc.



微波感应说明 Microwave sensor control function

(选配)



With Sensor



Time
10s-8min



Sens
0-12M



0-12meter

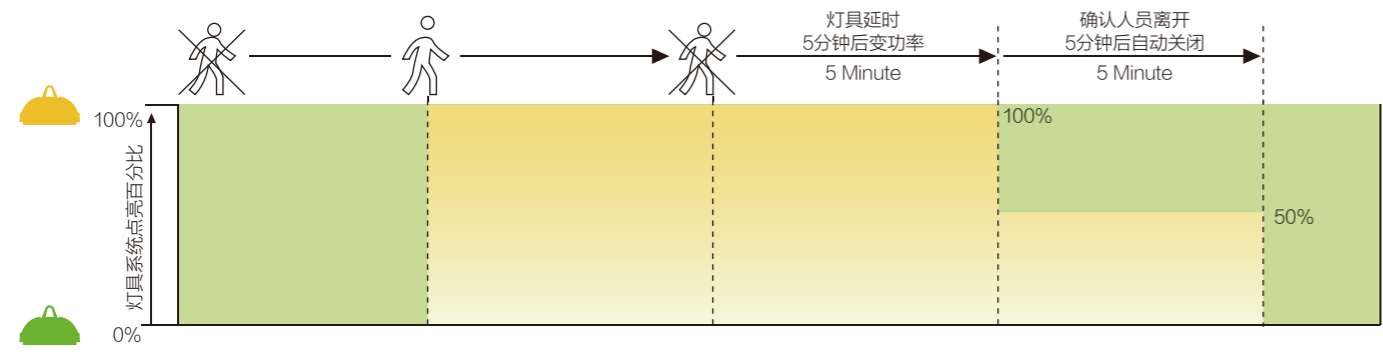

发光角度 Optics

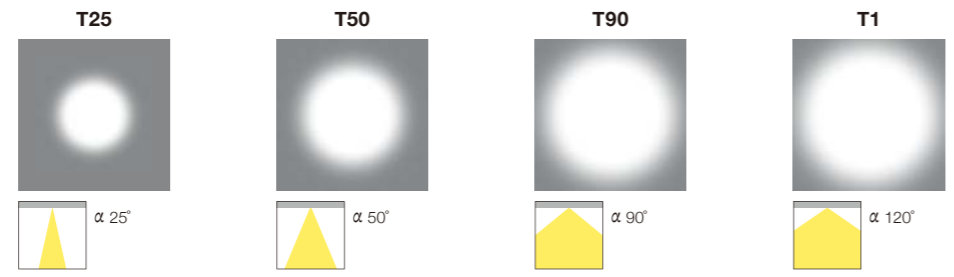

技术参数 Technology data



F-202M

Code	Power	LED Qty	Optics	Packing Size	Weight	Pcs/20"	Pcs/40"
LED chips - 3535/5050							
F-202MLED150-64	150W	64	T25/T60/T90/T1	450*450*205	7.8	600	1300
F-202MLED200-64	200W	64	T25/T60/T90/T1	450*450*205	7.8	600	1300
F-202MLED240-96	240W	96	T25D/T60D/T90D/T1D	450*450*205	7.8	600	1300

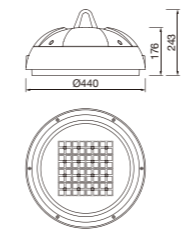

F-202S

Code	Power	LED Qty	Optics	Packing Size	Weight	Pcs/20"	Pcs/40"
LED chips - 3535/5050							
F-202SLED75-36	75W	36	T60/T90/T1	350*350*190	5.5	1056	2178
F-202SLED100-36	100W	36	T60/T90/T1	350*350*190	5.5	1056	2178
F-202SLED120-48	120W	48	T60D/T90D/T1D	350*350*190	5.5	1056	2178

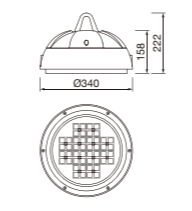

延伸产品 More in family



D-202MS / D-202SS
Street Lighting: 60~150W.



D-202MH / D-202SH
Street Lighting: 30~150W.



T-202SS
Street Lighting: 30~60W.



TG-202M / TG-202S
Flood Lighting: 75~240W.
Page. 44



F-03 Series



F-03SX
60-120W



F-03MX
150-240W

简述 Description

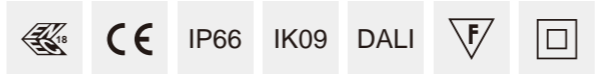

- 铝压铸灯体外壳，超白钢化玻璃，特殊外形设计，有2种尺寸供选择
- 高透光PC透镜，多种光学组件可选，具有高视觉舒适性和防眩效果
- 高性能LED芯片，有ON-OFF / DALI多种控制程序选项
- 灯具具有不同支架选项，可根据需要选配适用在不同场所
- 防紫外线聚氨酯塑料喷涂表面，耐腐蚀可以达1000小时以上
- 无生物蓝光危害风险，符合EN62471: 2008标准
- 所有外部螺钉均为304不锈钢材质

- Die-casting aluminium body, super white tempered glass. Special shape design, it has 2 sizes version options.
- Optics with PC lens with high visual comfortable and good anti glare effect, multiple light distribution options.
- High quality LED chips, with ON-OFF/DALI programmed options.
- The luminaire have multiple brackets to option, it can suit different application.
- Surface anti-ultraviolet pure polyester powder painting, Corrosion resistance can be more than 1000 hours.
- No photo-biological risk, in accordance with EN 62471:2008.
- All external screws are made of 304 stainless steel.

功率: 60W-240W
 光效: 120-155 Lm/W
 色温: 3000K / 4000K / 5000K
 显色指数: >80Ra / 90Ra
 功能选项: ON-OFF / DALI

Power: 60W-240W
 Nominal efficacy: 120-155 Lm/W
 CCT: 3000K / 4000K / 5000K
 CRI: >80Ra / 90Ra
 Options: ON-OFF / DALI

- 应用场合: 车间, 库房, 展览馆等场所等照明场所
- Applications: Workshop, warehouse, exhibition hall, etc.



技术参数 Technology data



F-03MX

Code	Power	LED Qty	Optics	Packing Size	Weight	Pcs/20"	Pcs/40"
LED chips - 3535/5050							
F-03MXLED150-64	150W	64	T25/T60/T90/T1	455*455*200	9.0	660	1430
F-03MXLED200-64	200W	64	T25/T60/T90/T1	455*455*200	9.3	660	1430
F-03MXLED240-96	240W	96	T25D/T60D/T90D/T1D	455*455*200	9.3	660	1430

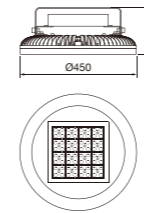

F-03SX

Code	Power	LED Qty	Optics	Packing Size	Weight	Pcs/20"	Pcs/40"
LED chips - 3535/5050							
F-03SXLED60-36	60W	36	T60/T90/T1	360*360*200	6.0	1056	2112
F-03SXLED75-36	75W	36	T60/T90/T1	360*360*200	6.0	1056	2112
F-03SXLED100-36	100W	36	T60/T90/T1	360*360*200	6.0	1056	2112
F-03SXLED120-54	120W	54	T60D/T90D/T1D	360*360*200	6.3	1056	2112

